

11338

MAZDA 5

5/26/2011

GROSS LOAD CAPACITY WHEN USED AS A WEIGHT CARRYING HITCH: 2,000 LBS. TRAILER WEIGHT & 200 LBS. TONGUE WEIGHT.

*****DO NOT EXCEED VEHICLE MANUFACTURER'S RECOMMENDED TOWING CAPACITY.*****

WARNING: ALL NON-TRAILER LOADS APPLIED TO THIS PRODUCT MUST BE SUPPORTED BY AUXILIARY STABILIZING STRAPS.

**** FAILURE TO PROPERLY SUPPORT NON-TRAILER LOADS WILL VOID PRODUCT WARRANTY****

HAVING INSTALLATION QUESTIONS? CALL TECHNICAL SUPPORT AT 1-800-798-0813

Parts List			
ITEM	QTY	PART NUMBER	DESCRIPTION
1	2	CM-SP2	.250 x .88 x 2.25" SQUARE HOLE SPACER
2	2	7/16 - 14 x 1 3/4	CARRIAGE BOLT
3	2	3_8 - 16 x 4 1_2 CARRIAGE	CARRIAGE BOLT
4	2	CM-SP18	.250 x 1.00 x 2.00" SQUARE HOLE SPACER
5	1	CM-438-FW	7/16" FISHWIRE TOOL
6	2	HFN3816	HEX FLANGE NUT
7	2	7/16-14	HEX FLANGE NUT

FISHWIRE TECHNIQUE

INSERT COILED END OF FISHWIRE TOOL THROUGH HITCH MOUNTING HOLE IN VEHICLE FRAME RAIL AND OUT THE ACCESS HOLE. PASS COILED END OF FISHWIRE THROUGH SPACER AND THREAD BOLT INTO COIL. KINK WIRE TO KEEP SPACER SEPERATE FROM BOLT AS SHOWN. PULL FISHWIRE, SPACER, AND BOLT THROUGH FRAME AND OUT MOUNTING HOLE. USE FISHWIRE TO GUIDE HITCH DURING MOUNTING AND PREVENT LOSS OF BOLT / SPACER INSIDE FRAME RAIL.

NOTE: SOME VEHICLES MAY FISHWIRE THROUGH END OF FRAME

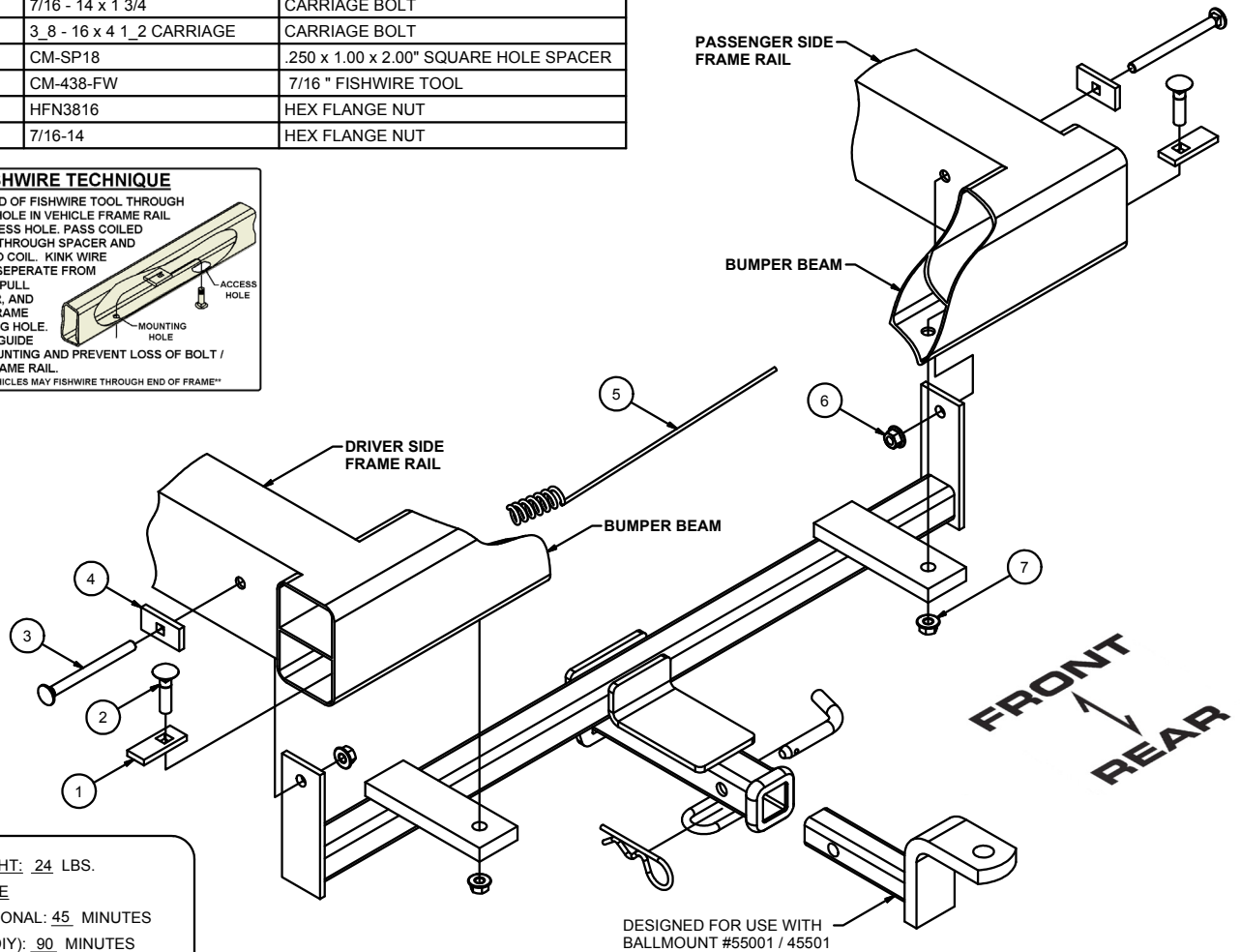

HITCH WEIGHT: 24 LBS.

INSTALL TIME

PROFESSIONAL: 45 MINUTES

NOVICE (DIY): 90 MINUTES

INSTALL NOTES:

- ENLARGE EXISTING HOLES

INSTALLATION STEPS

- 1) Locate hitch between frame rails and raise hitch into position. Install 4 1/2" carriage bolts and square hole spacers as shown.
- 2) Enlarge existing holes in bumper beam where necessary and position hitch against bumper beam. Fishwire 7/16" bolts and square hole spacers into position as shown. Install hex flange nuts.
- 3) Torque all 3/8" fasteners to 30 lb-ft, and all 7/16" fasteners to 50 lb-ft.

PERIODICALLY CHECK THIS RECEIVER HITCH TO ENSURE THAT ALL FASTENERS ARE TIGHT AND THAT ALL STRUCTURAL COMPONENTS ARE SOUND.

Curt Manufacturing Inc., warrants this product to be free of defects in material and/or workmanship at the time of retail purchase by the original purchaser. If the product is found to be defective, Curt Manufacturing Inc., may repair or replace the product, at their option, when the product is returned, prepaid, with proof of purchase. Alteration to, misuse of, or improper installation of this product voids the warranty. Curt Manufacturing Inc.'s liability is limited to repair or replacement of products found to be defective, and specifically excludes liability for incidental or consequential loss or damage.