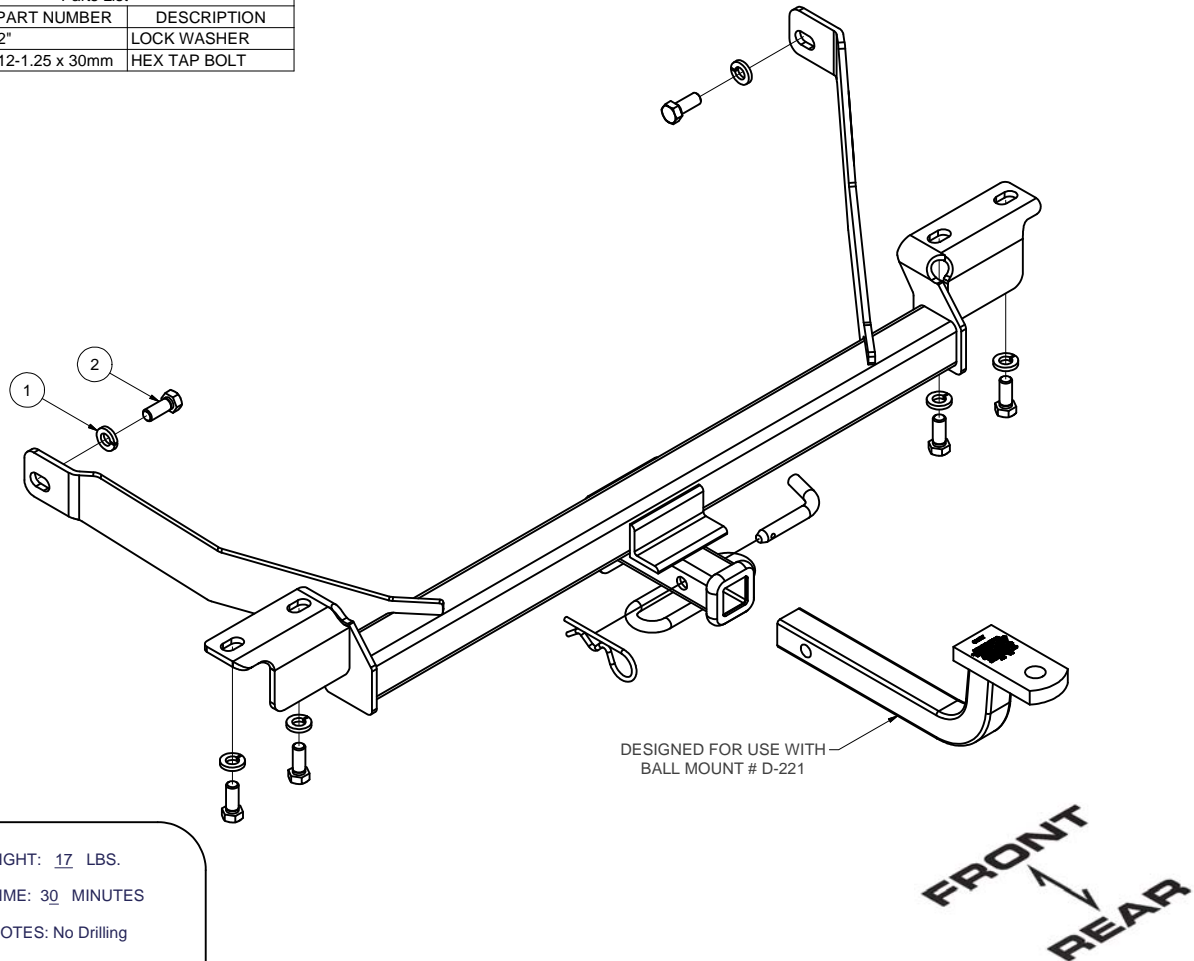

12102**99-02 Mercury Villager Van / 99-02 Nissan Quest Van**

9/26/2011

GROSS LOAD CAPACITY WHEN USED AS A WEIGHT CARRYING HITCH: 3,500 LBS. TRAILER WEIGHT & 350 LBS. TONGUE WEIGHT
*****DO NOT EXCEED VEHICLE MANUFACTURER'S RECOMMENDED TOWING CAPACITY***.**

Parts List			
ITEM	QTY	PART NUMBER	DESCRIPTION
1	6	1/2"	LOCK WASHER
2	6	M12-1.25 x 30mm	HEX TAP BOLT

HITCH WEIGHT: 17 LBS.INSTALL TIME: 30 MINUTES

INSTALL NOTES: No Drilling

INSTALLATION STEPS

- 1) Raise vehicle for access to underside.
- 2) Remove the (2) rearward most exhaust hangers to provide clearance for hitch installation..
- 3) Raise hitch into position by lifting right mounting plate up & over the tailpipe, and under the exhaust hanger bracket.
- 4) Line up the holes in the mounting plates with the existing weldnuts in the vehicle frame.
- 5) Secure hitch by inserting 12mm screws and washers.
- 6) Torque all 12mm fasteners to 68 LB.-FT.

PERIODICALLY CHECK THIS RECEIVER HITCH TO ENSURE THAT ALL FASTENERS ARE TIGHT AND THAT ALL STRUCTURAL COMPONENTS ARE SOUND.

Curt Manufacturing Inc., warrants this product to be free of defects in material or workmanship at the time of retail purchase by the original purchaser. If the product is found to be defective, Curt Manufacturing Inc., may repair or replace the product, at their option, when the product is returned, prepaid, with proof of purchase. Alteration to, misuse of, or improper installation of this product voids the warrant. Curt Manufacturing Inc.'s liability is limited to repair or replacement of products found to be defective, and specifically excludes liability for incidental or consequential loss or damage.