



Safety glasses should be worn at all times while installing this product.

YEARS: 2012

MAKE: LEXUS

MODEL: LS 460

STYLE: SEDAN

**WARNING: NEVER EXCEED YOUR VEHICLE MANUFACTURER'S RECOMMENDED TOWING CAPACITY**

**WEIGHT CARRYING:**  
 TRAILER WEIGHT: 3500 LBS.  
 TONGUE WEIGHT: 350 LBS.

**WARNING:**  
 WE RECOMMEND THE USE OF 18050 STABILIZING STRAPS FOR ALL NON-TRAILER (WHEEL-LESS) LOADS. PLEASE SEE THE CURT CATALOG OR VISIT US ONLINE AT [WWW.CURTMFG.COM](http://WWW.CURTMFG.COM) FOR FURTHER INFORMATION.

**PRO INSTALL TIME: 90 MIN.**  
**NOVICE INSTALL TIME: 180 MIN.**

IF YOU ARE HESITANT TO UNDERTAKE THIS TASK ON YOUR OWN, CONTACT AN AUTHORIZED CURT INSTALLER FOR ADDITIONAL ASSISTANCE.

**INSTALLATION TIPS:**

- BEFORE YOU BEGIN INSTALLATION, READ ALL INSTRUCTIONS THOROUGHLY.
- TO EASE INSTALLATION, 2 PEOPLE MAY BE REQUIRED.
- USING PROPER TOOLS WILL GREATLY IMPROVE THE QUALITY OF THE INSTALL AND REDUCE THE TIME REQUIRED.
- NEED HELP OR HAVE SOME QUESTIONS? CALL TECHNICAL SUPPORT AT 800.798.0813



**INSTALLATION REQUIRES:**

|  |                                 |                |
|--|---------------------------------|----------------|
| <b>FLAT &amp; PHILLIPS SCREW DRIVERS</b> | <b>10mm<br/>12mm<br/>SOCKET</b> | <b>RATCHET</b> |
| <b>TORQUE WRENCH</b>                     | <b>ROTARY TOOL</b>              | <b>MARKER</b>  |
| <b>6"<br/>SOCKET<br/>EXTENSION</b>       |                                 |                |
|  |                                 |                |

**LEVEL OF DIFFICULTY: CHALLENGING**

| EASY                        | MODERATE             | CHALLENGING |
|-----------------------------|----------------------|-------------|
| <b>TRIM</b>                 | TRIM UNDERBODY PANEL |             |
| <b>PART REMOVAL</b>         | REMOVE BUMPER        |             |
| <b>NO DRILLING REQUIRED</b> |                      |             |
|                             |                      |             |
|                             |                      |             |

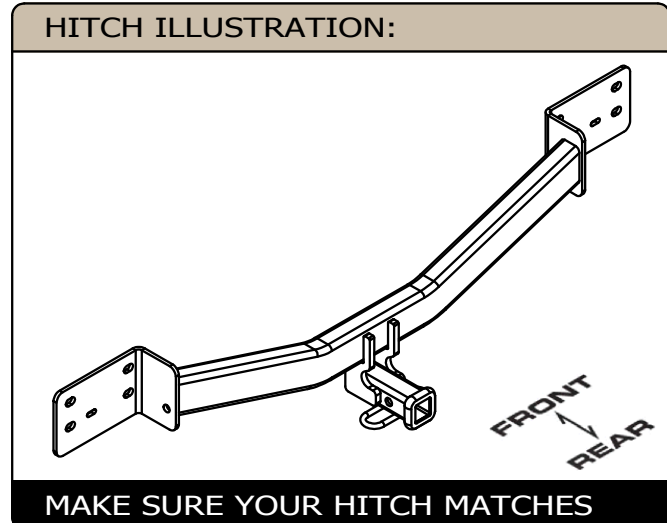

**PERIODICALLY CHECK THIS RECEIVER HITCH TO ENSURE ALL FASTENERS ARE TIGHT AND ALL STRUCTURAL COMPONENTS ARE SOUND**

CURT Manufacturing LLC. warrants this product to be free of defects in material and/or workmanship at the time of retail purchase by the original purchaser. If the product is found to be defective, Curt Manufacturing LLC. may repair or replace the product at their option, when the product is returned, prepaid, with proof of purchase. Alteration to, misuse of, or improper installation of this product voids the warranty. Curt Manufacturing LLC.'s liability is limited to repair or replacement of products found to be defective, and specifically excludes liability for incidental or consequential loss or damage.

For more information log onto [www.curtmfg.com](http://www.curtmfg.com), & for helpful towing tips log onto [www.hitchinfo.com](http://www.hitchinfo.com)

## INSTALLATION WALKTHROUGH:

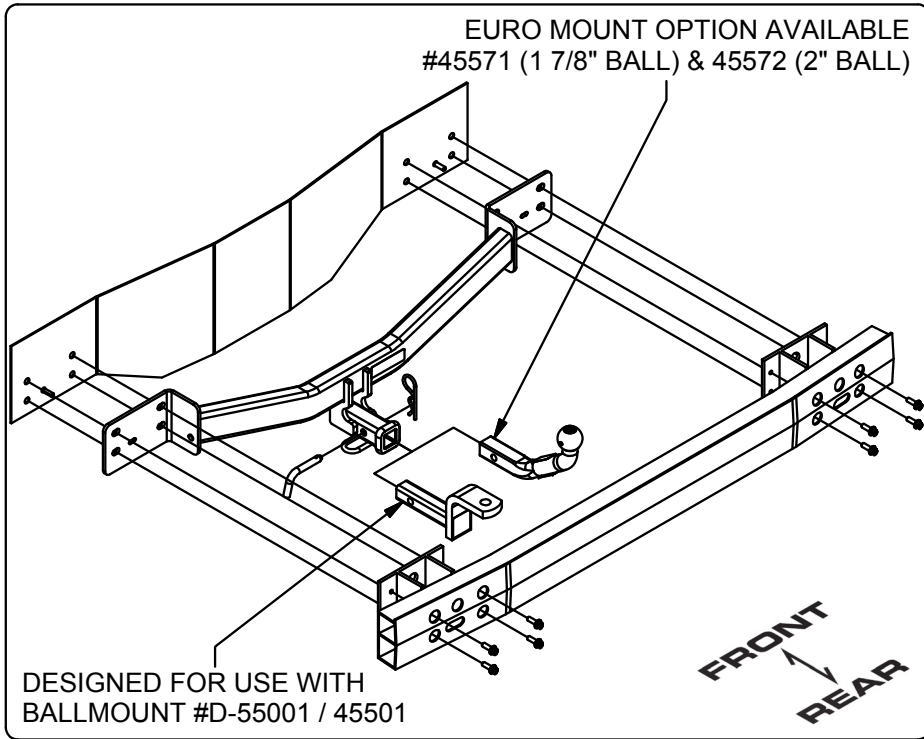

1. Remove underbody panel by removing (5) nuts and (5) push fasteners.



2. Begin bumper cover removal process by removing (1) screw and (1) push fastener from behind rear tire.

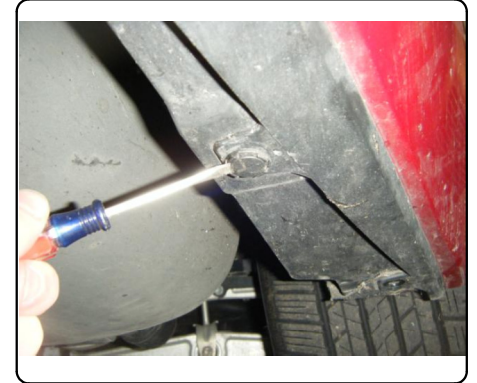

3. Remove (1) screw hidden behind the wheel well at the top of the fascia. Remove the plastic clip by prying it out with a flat head screw driver.

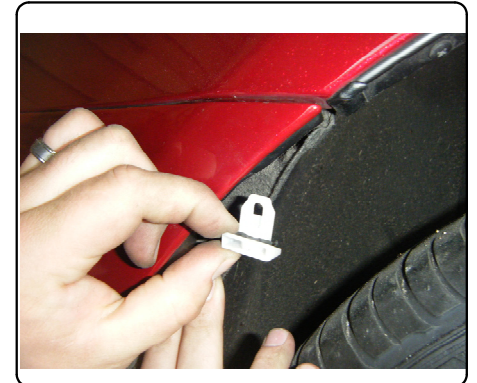
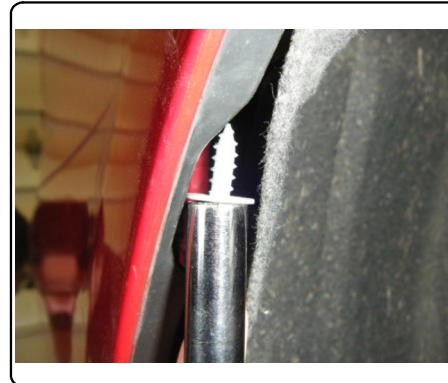

## INSTALLATION WALKTHROUGH:

4. Remove small plastic panel between tail light and trunk opening. Remove exposed screw.

Repeat STEPS 2-4 on the other side of the vehicle.

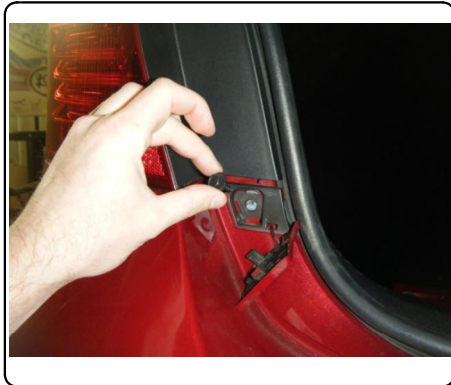
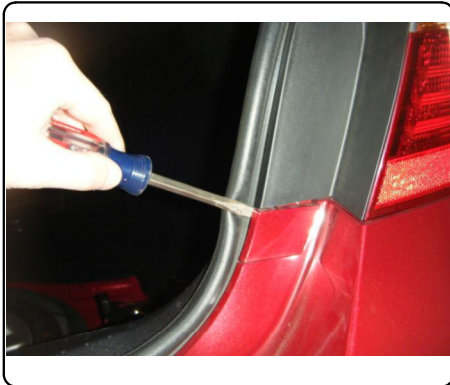

5. Carefully remove bumper cover. Pop sides off first and then pull straight back.

**NOTE:** Disconnect electrical connector under passenger side tail light.

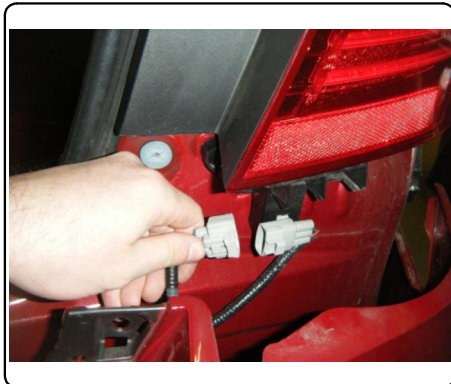
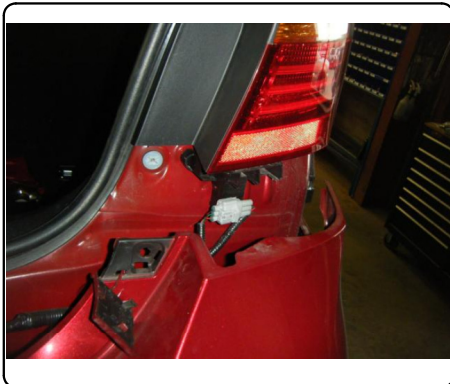

6. Remove foam and set aside for reinstall later.



7. Remove plastic blocks from bumper beam and set aside for reinstall later.

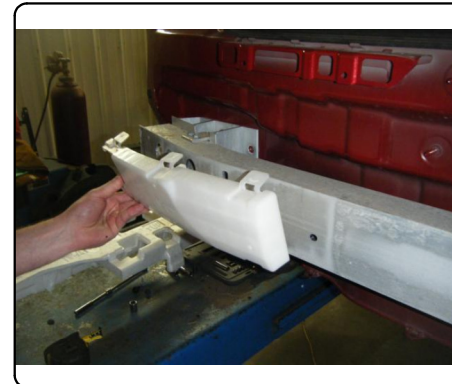
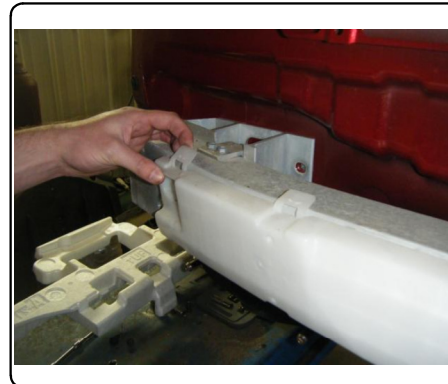

## INSTALLATION WALKTHROUGH:

8. Remove bumper beam by removing (8) M8 bolts.



9. Raise hitch and bumper beam into position and secure to the vehicle with the M8 bolts removed in STEP 9. Torque all M8 hardware to 23 ft-lbs.

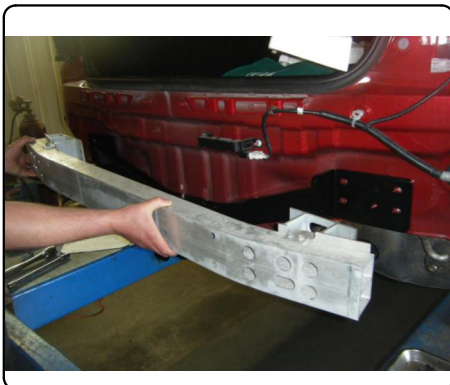

10. Reinstall bumper cover by reassembling components removed in STEPS 2-7 in reverse order. Trim underbody panel and reinstall.

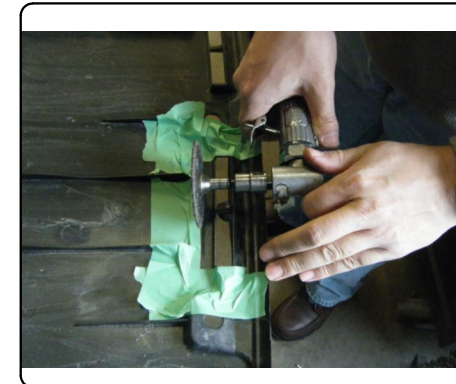
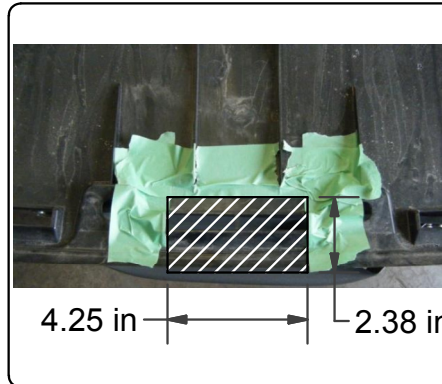

11. Install is now complete.

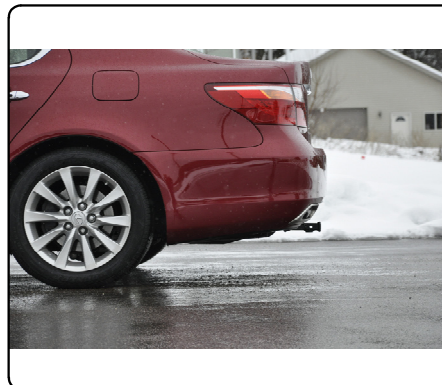

12114

2012 LEXUS LS 460

5/16/2013

GROSS LOAD CAPACITY WHEN USED AS A WEIGHT CARRYING HITCH: 3500 LBS. TRAILER WEIGHT & 350 LBS. TONGUE WEIGHT.

\*\*\*DO NOT EXCEED VEHICLE MANUFACTURER'S RECOMMENDED TOWING CAPACITY.\*\*\*

WARNING: ALL NON-TRAILER LOADS APPLIED TO THIS PRODUCT MUST BE SUPPORTED BY 18050 STABILIZING STRAPS.

\*\* FAILURE TO PROPERLY SUPPORT NON-TRAILER LOADS WILL VOID PRODUCT WARRANTY\*\*

HAVING INSTALLATION QUESTIONS? CALL TECHNICAL SUPPORT AT 1-800-798-0813

| TOOLS REQUIRED               |
|------------------------------|
| FLAT & PHILLIPS SCREW DRIVER |
| 10mm & 12mm SOCKETS          |
| RATCHET & 6" EXTENSION       |
| TORQUE WRENCH                |
| ROTARY TOOL                  |
| MARKER                       |

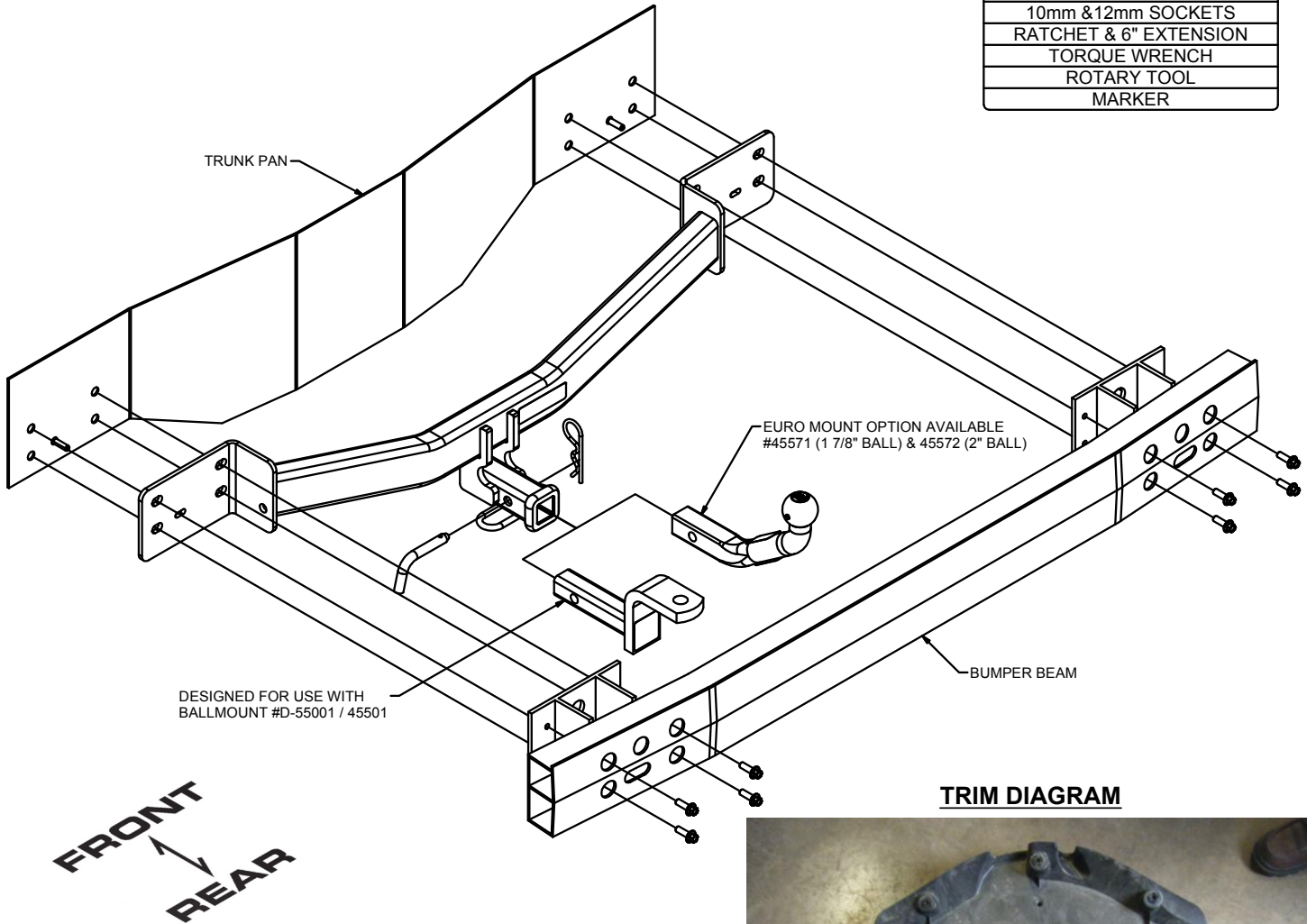

TRIM DIAGRAM



TRIM 4.25 in 2.38 in

HITCH WEIGHT: 22 LBS.

INSTALL TIME

PROFESSIONAL: 90 MINUTES

NOVICE (DIY): 180 MINUTES

INSTALL NOTES:

- REMOVE BUMPER
- TRIM UNDERBODY PANEL
- NO DRILLING REQUIRED

**PERIODICALLY CHECK THIS RECEIVER HITCH TO ENSURE THAT ALL FASTENERS ARE TIGHT AND THAT ALL STRUCTURAL COMPONENTS ARE SOUND.**

Curt Manufacturing LLC., warrants this product to be free of defects in material and/or workmanship at the time of retail purchase by the original purchaser. If the product is found to be defective, Curt Manufacturing LLC., may repair or replace the product, at their option, when the product is returned, prepaid, with proof of purchase. Alteration to, misuse of, or improper installation of this product voids the warranty. Curt Manufacturing LLC.'s liability is limited to repair or replacement of products found to be defective, and specifically excludes liability for incidental or consequential loss or damage.

**INSTALLATION STEPS**

1. Remove underbody panel by removing (5) nuts and (5) push fasteners.
2. Begin bumper cover removal process by removing (1) screw and (1) push fastener from behind rear tire.
3. Remove (1) screw hidden behind the wheel well at the top of the fascia. Remove the plastic clip by prying it out with a flat head screw driver.
4. Remove small plastic panel between tail light and trunk opening. Remove the exposed screw.
5. Repeat STEPS 2 -4 on the other side of the vehicle.
6. Carefully remove bumper cover. Pop sides off first and then pull straight back.  
**Note:** Disconnect electrical connector under passenger side tail light.
7. Remove foam and set aside for reinstall later.
8. Remove plastic blocks from bumper beam and set aside for reinstall later.
9. Remove bumper beam by removing (8) M8 bolts.
10. Raise hitch and bumper beam into position and secure to the vehicle with the M8 bolts removed in STEP 9.
11. Torque all M8 hardware to 23 ft-lbs.
12. Reinstall bumper cover by reassembling components removed in STEPS 2-8 in reverse order.
13. Trim underbody panel and reinstall. See TRIM DIAGRAM.

**PERIODICALLY CHECK THIS RECEIVER HITCH TO ENSURE THAT ALL FASTENERS ARE TIGHT AND THAT ALL STRUCTURAL COMPONENTS ARE SOUND.**