

12293**03-06 MITSUBISHI OUTLANDER**

4/13/2011

GROSS LOAD CAPACITY WHEN USED AS A WEIGHT CARRYING HITCH: 3,500 LBS. TRAILER WEIGHT & 300 LBS. TONGUE WEIGHT.
 DO NOT EXCEED VEHICLE MANUFACTURER'S RECOMMENDED TOWING CAPACITY.

Parts List			
ITEM	QTY	PART NUMBER	DESCRIPTION
1	8	M10-1.25 x 35	HEX BOLT
2	8	7/16"	CONICAL TOOTHED WASHER

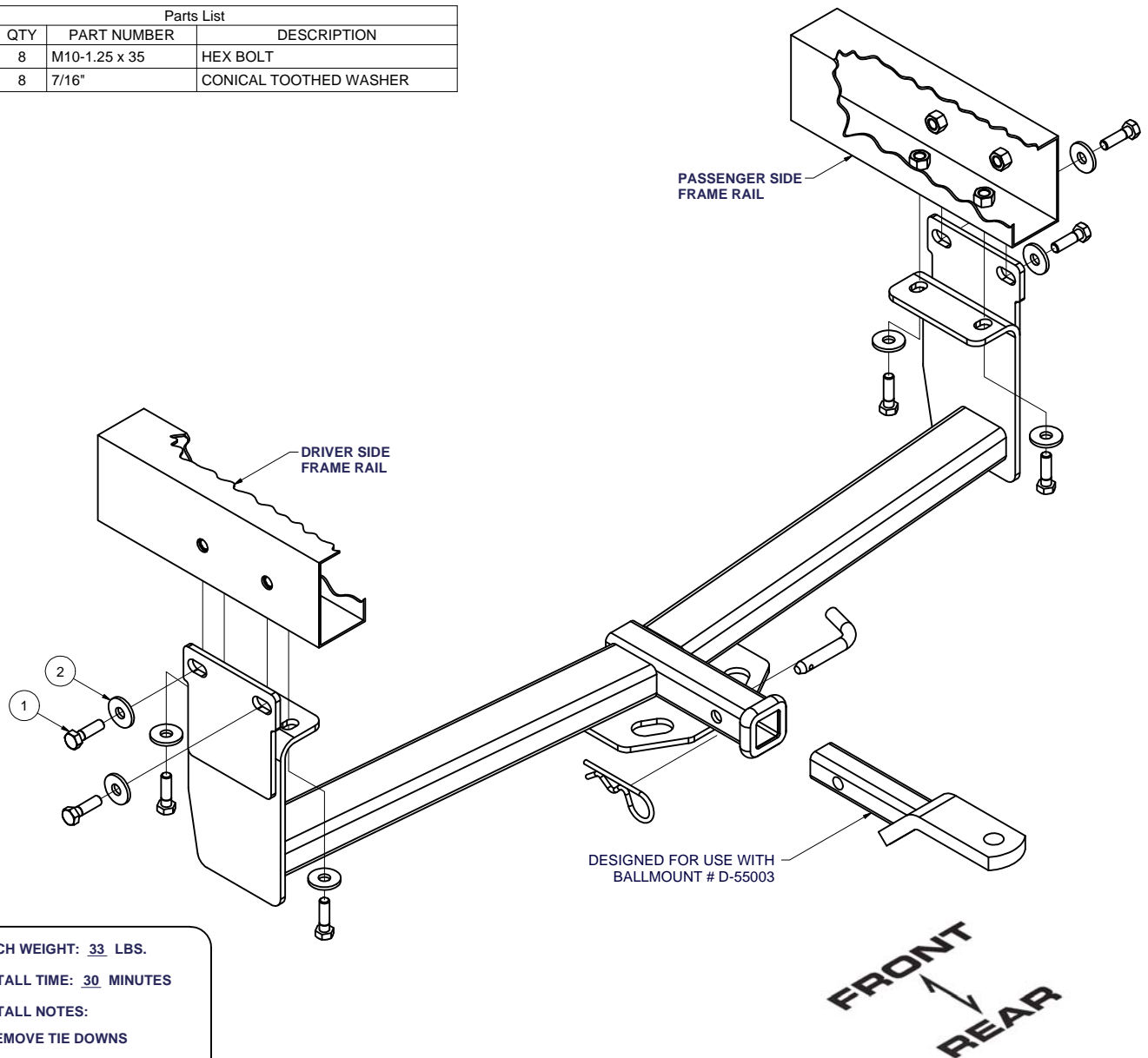

HITCH WEIGHT: 33 LBS.

INSTALL TIME: 30 MINUTES

INSTALL NOTES:

- REMOVE TIE DOWNS

INSTALLATION STEPS

- 1) Remove left and right tie down brackets from vehicle frame rails.
- 2) Position hitch on vehicle frame rails aligning hitch holes with weld nuts. Fasten hitch using fasteners as shown.
- 3) Torque all 10mm fasteners to 35 lb.-ft.

PERIODICALLY CHECK THIS RECEIVER HITCH TO ENSURE THAT ALL FASTENERS ARE TIGHT AND THAT ALL STRUCTURAL COMPONENTS ARE SOUND.

Curt Manufacturing Inc., warrants this product to be free of defects in material and/or workmanship at the time of retail purchase by the original purchaser. If the product is found to be defective, Curt Manufacturing Inc., may repair or replace the product, at their option, when the product is returned, prepaid, with proof of purchase. Alteration to, misuse of, or improper installation of this product voids the warranty. Curt Manufacturing Inc.'s liability is limited to repair or replacement of products found to be defective, and specifically excludes liability for incidental or consequential loss or damage.