

13210 GMC & CHEVY 2500HD / 3500 / 3500HD SIERRA & SILVERADO TRUCKS, CLASSIC & NEW BODY - ALL

2/15/08

GROSS LOAD CAPACITY WHEN USED AS A WEIGHT CARRYING HITCH: 6,000 LBS. TRAILER WEIGHT & 600 LBS. TONGUE WEIGHT.
GROSS LOAD CAPACITY WHEN USED AS A WEIGHT DISTRIBUTION HITCH: 10,000 LBS. TRAILER WEIGHT & 1,000 LBS. TONGUE WEIGHT

*****DO NOT EXCEED VEHICLE MANUFACTURER'S RECOMMENDED TOWING CAPACITY.*****

Parts List				
ITEM	QTY	PART NUMBER	DESCRIPTION	
1	2	HFN 1213	HEX FLANGE NUT	
2	4	9/16	LOCK WASHER	
3	2	1/2-13 x 1 3/4	CARRIAGE BOLT	
4	2	CM-SP22	.250 x 1.50 x 1.50" ROUND HOLE SPACER	
5	2	CM-SP1	.250 x 1.50 x 2.00" SQUARE HOLE SPACER	
6	12	9_16 WASHER	FLAT WASHER	
7	4	M14-2 x 40mm LG.	HEX BOLT	

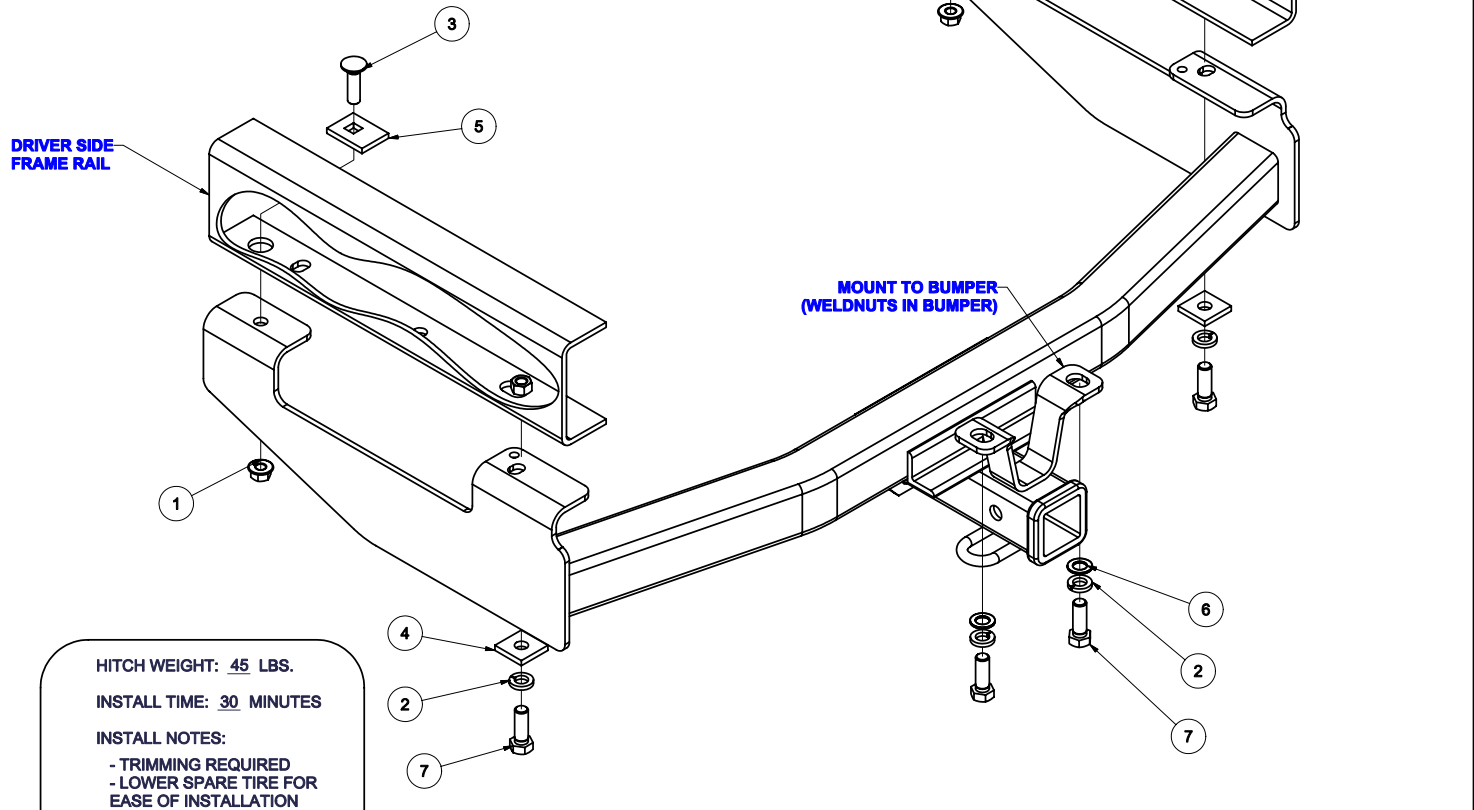

HITCH WEIGHT: 45 LBS.

INSTALL TIME: 30 MINUTES

INSTALL NOTES:

- TRIMMING REQUIRED
- LOWER SPARE TIRE FOR EASE OF INSTALLATION

INSTALLATION STEPS

- 1) Remove existing 14M fasteners from end of each frame rail if present and return to customer.
- 2) Trim bumper fascia as needed for access to weldnuts in bumper and clearance for bumper mount.
- 3) Lift receiver into position, locating slots in hitch over weldnuts in vehicle frame.
- 4) Install 14M fasteners through hitch into weldnuts in vehicle frame and bumper.

Note: Install (1-4) 9/16" washers per side between hitch and bumper attachment as needed for variations in bumper height.

- 5) Torque all 14M fasteners to 94 lb-ft, and all 1/2" fasteners to 75 lb-ft.

PERIODICALLY CHECK THIS RECEIVER HITCH TO ENSURE THAT ALL FASTENERS ARE TIGHT AND THAT ALL STRUCTURAL COMPONENTS ARE SOUND.

Curt Manufacturing Inc., warrants this product to be free of defects in material and/or workmanship at the time of retail purchase by the original purchaser. If the product is found to be defective, Curt Manufacturing Inc., may repair or replace the product, at their option, when the product is returned, prepaid, with proof of purchase. Alteration to, misuse of, or improper installation of this product voids the warranty. Curt Manufacturing Inc.'s liability is limited to repair or replacement of products found to be defective, and specifically excludes liability for incidental or consequential loss or damage.