

13517

99-05 GEO/CHEVY TRACKER, 99-05 SUZUKI VITARA/GRAND VITARA,
02-06 SUZUKI XL7

7/21/08

GROSS LOAD CAPACITY WHEN USED AS A WEIGHT CARRYING HITCH: 3,500 LBS. TRAILER WEIGHT & 350 LBS. TONGUE WEIGHT.
GROSS LOAD CAPACITY WHEN USED AS A WEIGHT DISTRIBUTION HITCH: 4,000 LBS. TRAILER WEIGHT & 400 LBS. TONGUE WEIGHT

*****DO NOT EXCEED VEHICLE MANUFACTURER'S RECOMMENDED TOWING CAPACITY.*****

Parts List			
ITEM	QTY	PART NUMBER	DESCRIPTION
1	4	M12 - 1.25 x 40 HEX	HEX BOLT
2	4	1/2"	WASHER
3	4	1/2"	LOCK WASHER

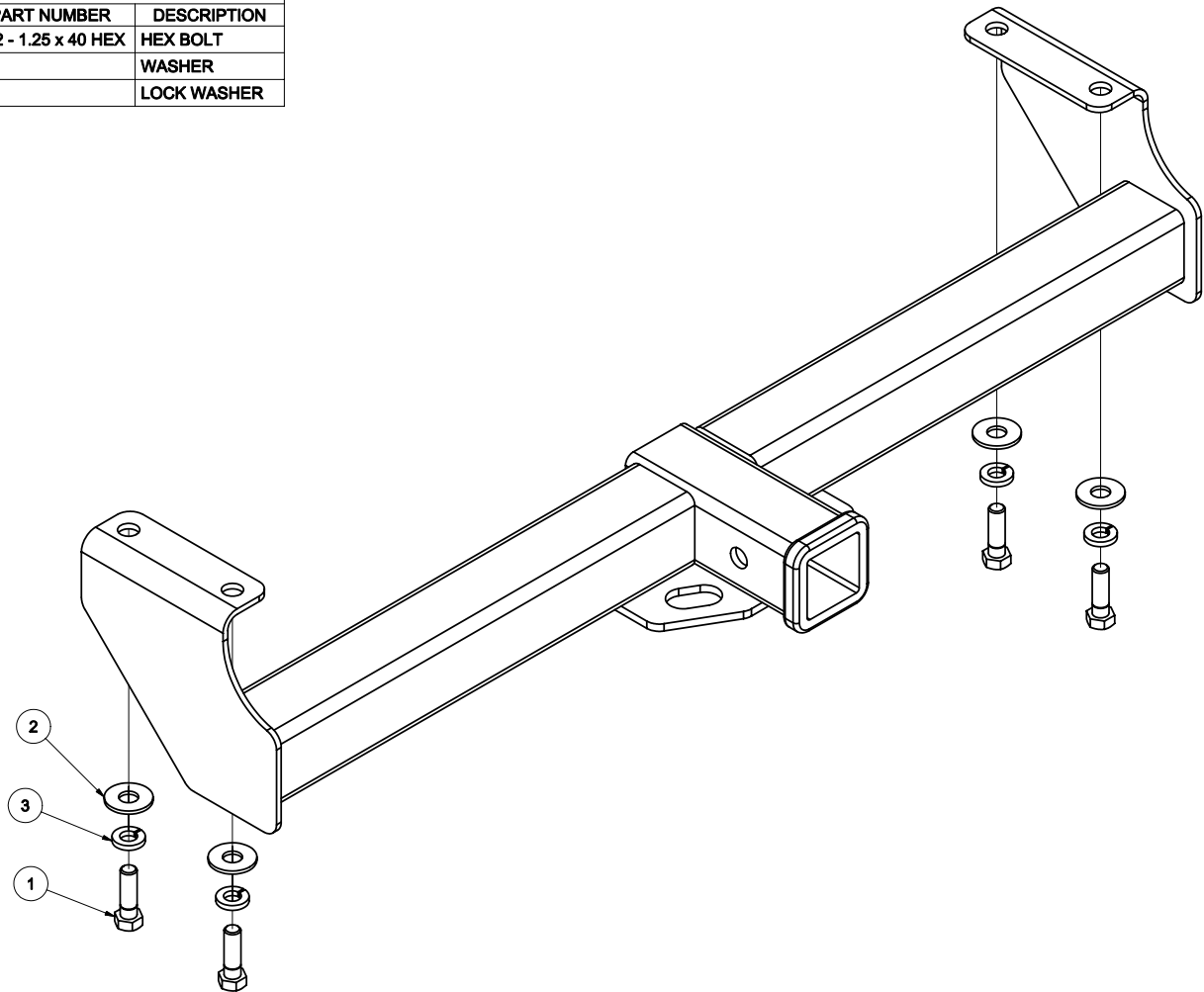

HITCH WEIGHT: 23 LBS.

INSTALL TIME: 40 MINUTES

INSTALL NOTES:

-NO DRILLING REQUIRED

INSTALLATION STEPS

- 1) Raise hitch into position.
- 2) Insert M12 fasteners as shown through hitch and into existing frame weldnuts.
- 3) Torque all M12 hardware to 65 lb-ft.

PERIODICALLY CHECK THIS RECEIVER HITCH TO ENSURE THAT ALL FASTENERS ARE TIGHT AND THAT ALL STRUCTURAL COMPONENTS ARE SOUND.

Curt Manufacturing Inc., warrants this product to be free of defects in material and/or workmanship at the time of retail purchase by the original purchaser. If the product is found to be defective, Curt Manufacturing Inc., may repair or replace the product, at their option, when the product is returned, prepaid, with proof of purchase. Alteration to, misuse of, or improper installation of this product voids the warranty. Curt Manufacturing Inc.'s liability is limited to repair or replacement of products found to be defective, and specifically excludes liability for incidental or consequential loss or damage.