



Safety glasses should be worn at all times while installing this product.

YEARS: 2005 TO 2010

MAKE: JEEP

MODEL: GRAND CHEROKEE & ROCKY MOUNTAIN EDITION

STYLE: SUV

WARNING: NEVER EXCEED YOUR VEHICLE MANUFACTURER'S RECOMMENDED TOWING CAPACITY

WEIGHT CARRYING:
TRAILER WEIGHT: 3,000 LBS.
TONGUE WEIGHT: 300 LBS.

GROSS LOAD CAPACITY WHEN USED AS A STRAIGHT LINE PULL:
9,000 LBS MAX.

INSTALLATION TIME: 90 MIN.

THE INSTALL TIME LISTED IS FOR PROFESSIONAL INSTALLERS. IF YOU ARE HESITANT TO UNDERTAKE THIS TASK ON YOUR OWN, CONTACT AN AUTHORIZED CURT INSTALLER FOR ADDITIONAL ASSISTANCE.

INSTALLATION REQUIRES:

SAFETY GLASSES	RATCHET	3/4" 9/32" 15 mm 10 mm SOCKET
TORQUE WRENCH	DIE GRINDER (OPTIONAL)	UTILITY KNIFE (OPTIONAL)

INSTALLATION TIPS:

- BEFORE YOU BEGIN INSTALLATION, READ ALL INSTRUCTIONS THOROUGHLY.
- TO EASE INSTALLATION, 2 PEOPLE MAY BE REQUIRED.
- USING PROPER TOOLS WILL GREATLY IMPROVE THE QUALITY OF THE INSTALL AND REDUCE THE TIME REQUIRED.
- NEED HELP OR HAVE SOME QUESTIONS? CALL TECHNICAL SUPPORT AT 800.798.0813

LEVEL OF DIFFICULTY: HARD

EASY	MODERATE	HARD
PART REMOVAL	REMOVE AIR DAM REMOVE GRILL REMOVE FRONT BUMPER (MODELS WITH TOW HOOKS)	
TRIM	OPTIONAL FASCIA TRIMMING (REQUIRED ON 2010 MODELS)	
	OPTIONAL HOLE ENLARGEMENT	
	FISHWIRE HARDWARE	
	REVERSE FISHWIRE HARDWARE	

VEHICLE PHOTO:



REPRESENTATIVE PHOTO

HITCH ILLUSTRATION:

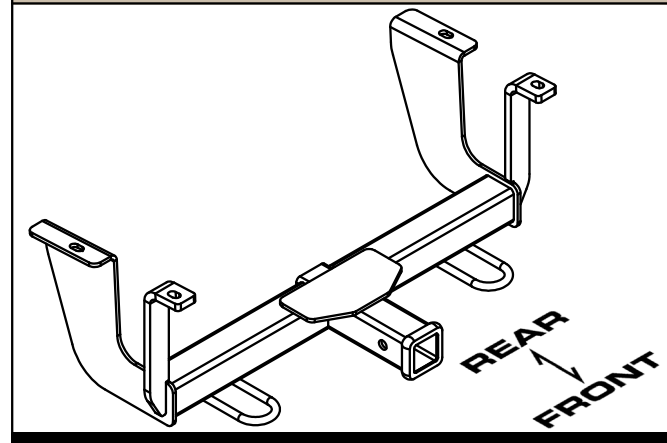

MAKE SURE YOUR HITCH MATCHES

PERIODICALLY CHECK THIS RECEIVER HITCH TO ENSURE ALL FASTENERS ARE TIGHT AND ALL STRUCTURAL COMPONENTS ARE SOUND

CURT Manufacturing Inc. warrants this product to be free of defects in material and/or workmanship at the time of retail purchase by the original purchaser. If the product is found to be defective, Curt Manufacturing Inc. may repair or replace the product at their option, when the product is returned, prepaid, with proof of purchase. Alteration to, misuse of, or improper installation of this product voids the warranty. Curt Manufacturing Inc.'s liability is limited to repair or replacement of products found to be defective, and specifically excludes liability for incidental or consequential loss or damage.

For more information log onto www.curtmfg.com, & for helpful towing tips log onto www.hitchinfo.com

INSTALLATION WALKTHROUGH:

Parts List			
ITEM	QTY	PART NUMBER	DESCRIPTION
1	4	1/2-13 x 1 1/2	CARRIAGE BOLT
2	4	CM-SP17	.250 x 1.25 x 2.50" SQUARE HOLE SPACER
3	4	HFN 1213	HEX FLANGE NUT
4	4	1_2 FISHWIRE	1/2" FISHWIRE

FISHWIRE TECHNIQUE

INSERT COILED END OF FISHWIRE TOOL THROUGH HITCH MOUNTING HOLE IN VEHICLE FRAME RAIL AND OUT THE ACCESS HOLE. PASS COILED END OF FISHWIRE THROUGH SPACER AND THREAD BOLT INTO COIL. KINK WIRE TO KEEP SPACER SEPERATE FROM BOLT AS SHOWN. PULL FISHWIRE, SPACER, AND BOLT THROUGH FRAME AND OUT MOUNTING HOLE. USE FISHWIRE TO GUIDE HITCH DURING MOUNTING AND PREVENT LOSS OF BOLT / SPACER INSIDE FRAME RAIL.

NOTE: SOME VEHICLES MAY FISHWIRE THROUGH END OF FRAME

REVERSE PULL FISHWIRE TECHNIQUE

ATTACH FISHWIRE TO CARRIAGE BOLT AND SLIDE SPACER ONTO FISHWIRE. PUSH THE BOLT THRU THE HOLE FOLLOWED BY THE SPACER (AS SHOWN). PULL BOLT BACK INTO POSITION, PROTRUDING FROM THE FRAME.

NOTE: (Steps 1, 14-16 are for 2010 models only. All other model years skip to step 2)

1. Remove air dam and plastic grill panel by removing (7) plastic fasteners, (3) bolts, and (6) clips. If vehicle is equipped with factory installed tow hooks skip to step 3 (no hole enlargement required). If no tow hooks are present and hole enlargement is preferred skip to step 10.

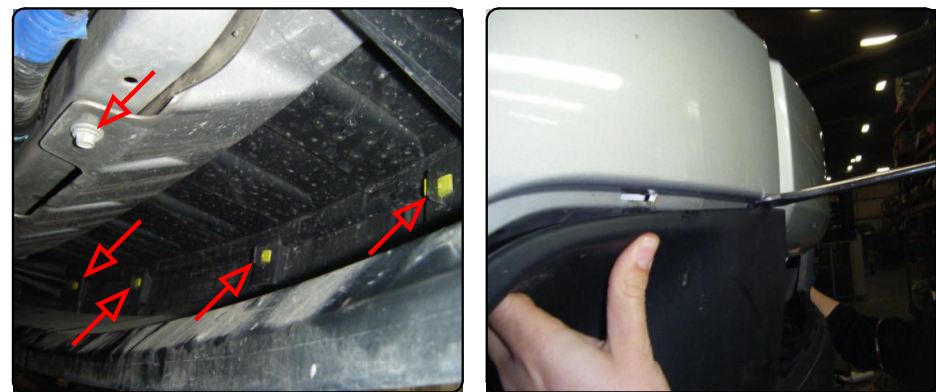

2. Remove air dam by removing (5) plastic fasteners. If optional trimming is selected this will occur in step 18.



INSTALLATION WALKTHROUGH:

NOTE: (Steps 3-9 are for models equipped with factory installed tow hooks and no hole enlargement is required. If hole enlargement is preferred on vehicles without tow hooks skip to step 10)

3. Take off vehicle grill by removing (6) plastic fasteners.

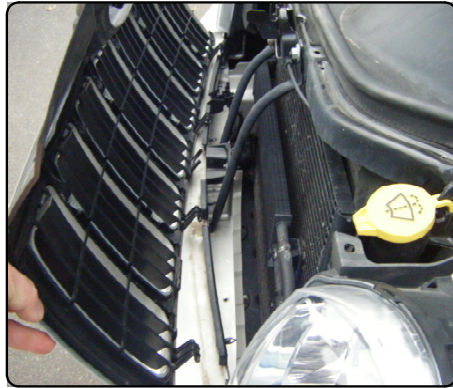

4. Begin the removal of front bumper cover by first removing the (3) lower screws from the bottom of bumper cover. Then remove the (5) plastic fasteners from top of bumper cover.



5. Continue bumper cover removal by removing (2) plastic fasteners and (1) socket screw in each wheel well.



6. Carefully pull bumper away from frame. Twist and remove head light lamps from their housing units. Place bumper off to the side.



INSTALLATION WALKTHROUGH:

7. Remove factory tow hooks and lock nuts. These will not be reinstalled, return to vehicle owner.

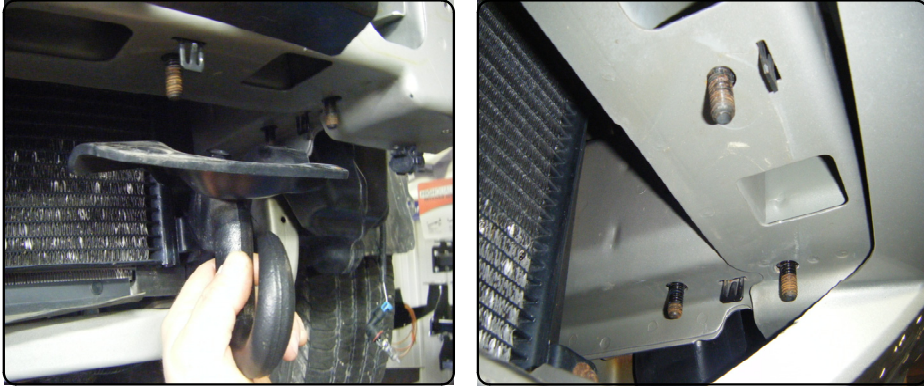

8. Remove the front frame end caps to allow removal of factory installed tow hook hardware.

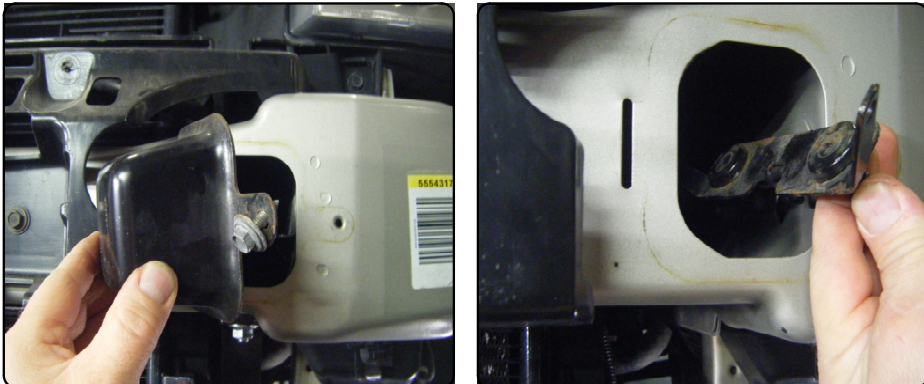

9. Fishwire (2) carriage bolts and spacers through the front of each frame rail, as shown below and in the illustration on sheet 2.

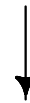
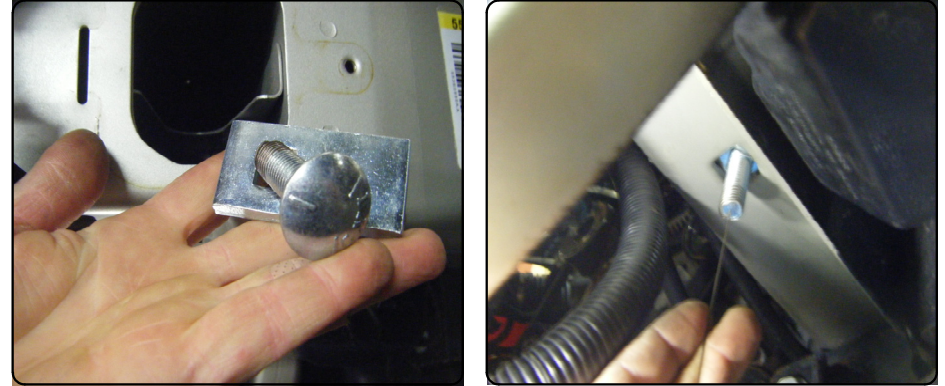

NOTE: (Steps 10-12 are for the hole enlargement option)

10. Enlarge the square mounting hole on each frame rail so that the included 1/2" hardware can pass through.

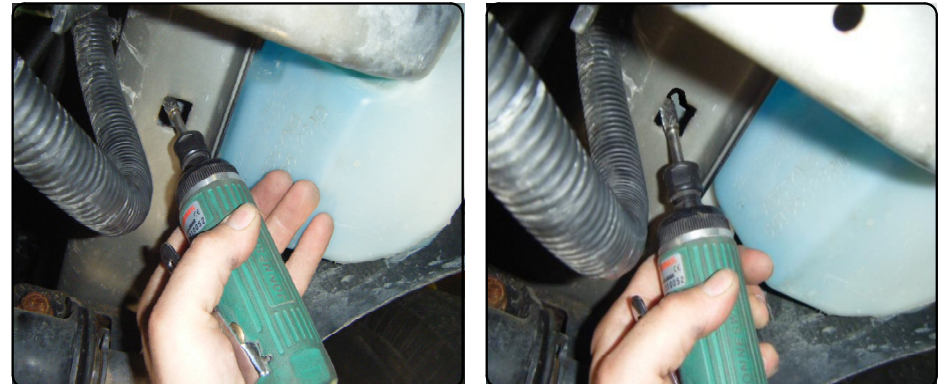

INSTALLATION WALKTHROUGH:

11. Fishwire 1/2" carriage bolt and CM-SP17 spacer into front mounting hole on each side.

(See FISHWIRE TECHNIQUE on sheet 2)



12. Reverse fishwire 1/2" carriage bolt and CM-SP17 spacer into rear mounting hole on each side.

(See REVERSE PULL FISHWIRE TECHNIQUE on sheet 2)



13. Using the fishwires on the carriage bolts as a guide raise hitch into position. (Rubber guards will need to be temporarily flipped out of the way on 2010 models)
Remove the fishwires and secure with flange nuts.

Torque all 1/2" hardware to 75 ft-lbs.

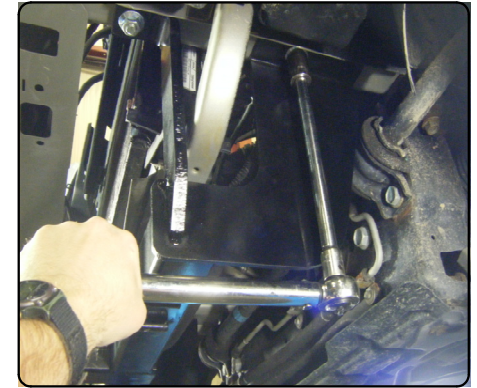
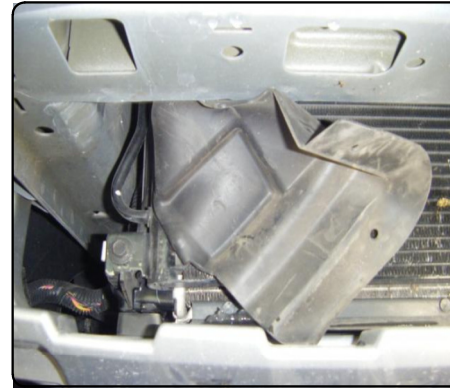

14. On 2010 models, trim fascia so it is able to be fastened back onto vehicle cross member. (See TRIM DIAGRAM below) Trim dimensions are approximate. Check fit prior trimming.

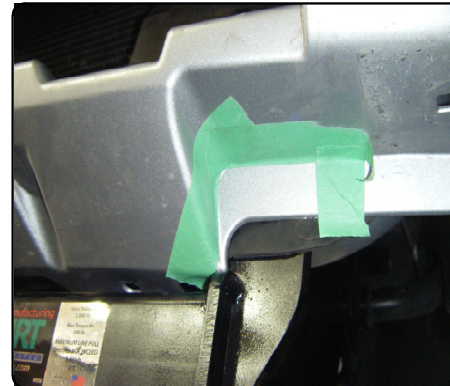

TRIM DIAGRAM
(2010 MODELS ONLY)

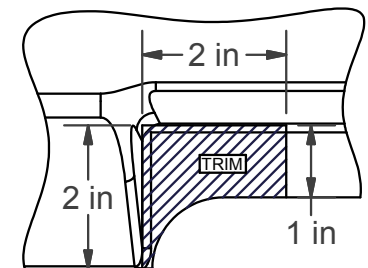

INSTALLATION WALKTHROUGH:

15. If removed in step 1, reinstall plastic grill panel.

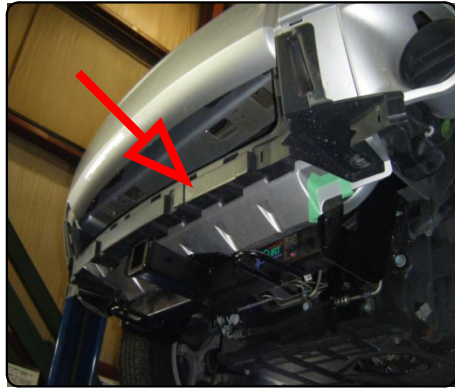

17. Reinstall frame endcaps, headlights, bumper cover and grill, if removed in steps 3-9.



16. If removed in step 1, raise air dam into position and mark location to trim for receiver tube. After hole is trimmed for the receiver tube, raise air dam back into position and mark trim locations for the hitch chain loops (See below). Trim dimensions are approximate. Check fit prior to trimming. Reinstall air dam.



TRIM DIAGRAM
(2010 MODELS ONLY)

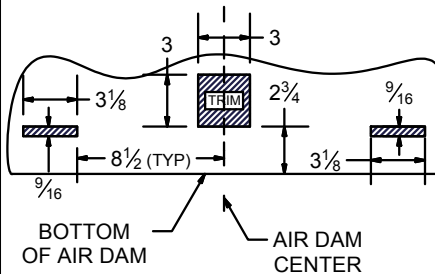

NOTE: (Air dam trimming option for 2005-2009 models)

18. Trim an approximate 2 5/8" square from the center bottom portion of air dam. Trim dimensions are approximate. Check fit prior to trimming. Reinstall air dam.

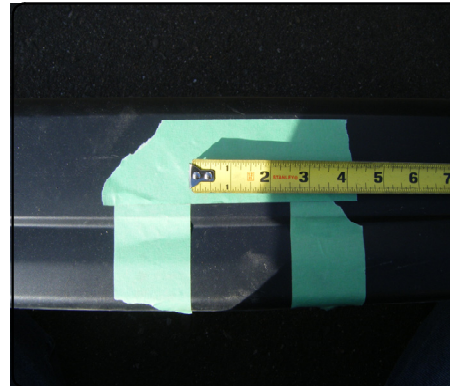

31047 JEEP GRAND CHEROKEE & ROCKY MOUNTAIN EDITION

12/7/2010

GROSS LOAD CAPACITY WHEN USED AS A WEIGHT CARRYING HITCH: 3,000 LBS. TRAILER WEIGHT & 300 LBS. TONGUE WEIGHT.
 GROSS LOAD CAPACITY WHEN USED AS A STRAIGHT LINE PULL: 9,000 LBS. MAX. LINE PULL.

***** DO NOT EXCEED VEHICLE MANUFACTURER'S RECOMMENDED TOWING CAPACITY. *****
 HAVING INSTALLATION QUESTIONS? CALL TECHNICAL SUPPORT AT 1-800-798-0813

Parts List			
ITEM	QTY	PART NUMBER	DESCRIPTION
1	4	1/2-13 x 1 1/2	CARRIAGE BOLT
2	4	CM-SP17	.250 x 1.25 x 2.50" SQUARE HOLE SPACER
3	4	HFN 1213	HEX FLANGE NUT
4	4	1_2 FISHWIRE	1/2" FISHWIRE

TOOLS REQUIRED	
RATCHET	
3/4" & 9/32" SOCKETS	
10mm & 15mm SOCKETS	
DIE GRINDER (OPTIONAL)	
UTILITY KNIFE (OPTIONAL)	
TORQUE WRENCH	

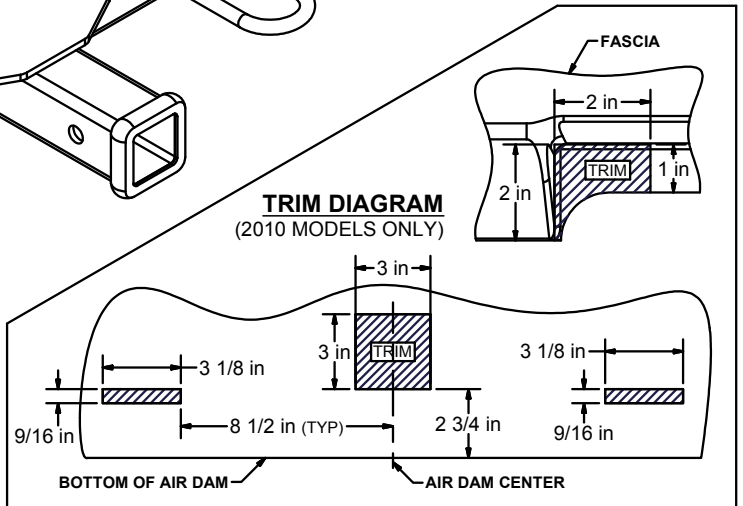
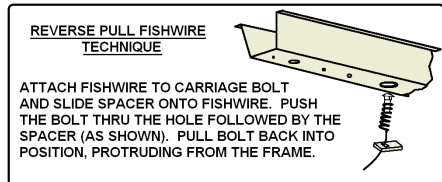
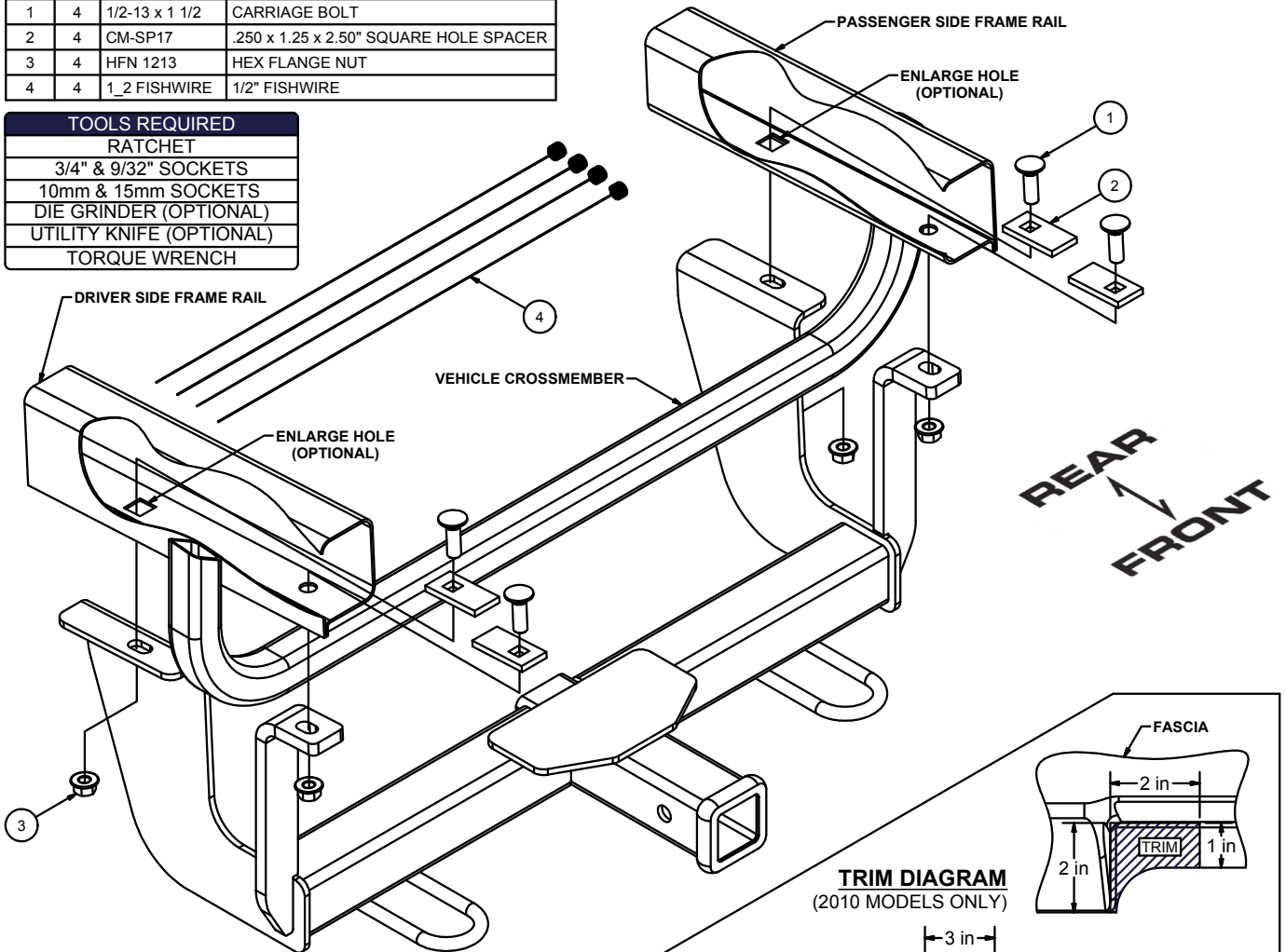

HITCH WEIGHT: .39 LBS.
INSTALL TIME
 PROFESSIONAL: 60 MINUTES
 NOVICE (DIY): 120 MINUTES
INSTALL NOTES:
 -FISHWIRE HARDWARE
 -OPTIONAL HOLE ENLARGEMENT
 -GRILL / FRONT BUMPER REMOVAL (MODELS WITH TOW HOOKS)
 -OPTIONAL FASCIA TRIMMING (REQUIRED ON 2010 MODELS)

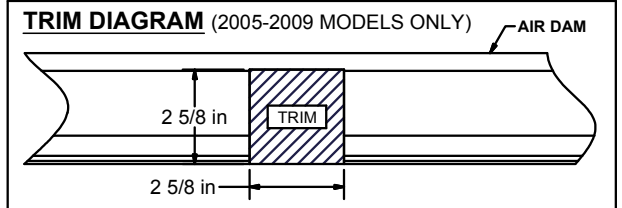
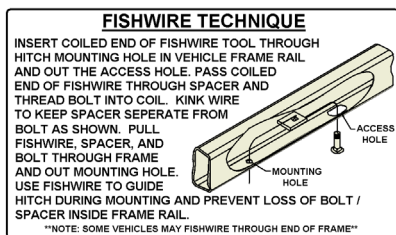

PERIODICALLY CHECK THIS RECEIVER HITCH TO ENSURE THAT ALL FASTENERS ARE TIGHT AND THAT ALL STRUCTURAL COMPONENTS ARE SOUND.

Curt Manufacturing Inc., warrants this product to be free of defects in material and/or workmanship at the time of retail purchase by the original purchaser. If the product is found to be defective, Curt Manufacturing Inc., may repair or replace the product, at their option, when the product is returned, prepaid, with proof of purchase. Alteration to, misuse of, or improper installation of this product voids the warranty. Curt Manufacturing Inc.'s liability is limited to repair or replacement of products found to be defective, and specifically excludes liability for incidental or consequential loss or damage.

31047 JEEP GRAND CHEROKEE & ROCKY MOUNTAIN EDITION

12/7/2010

GROSS LOAD CAPACITY WHEN USED AS A WEIGHT CARRYING HITCH: 3000 LBS. TRAILER WEIGHT & 300 LBS. TONGUE WEIGHT.

GROSS LOAD CAPACITY WHEN USED AS A STRAIGHT LINE PULL: 9,000 LBS. MAX. LINE PULL.

***** DO NOT EXCEED VEHICLE MANUFACTURER'S RECOMMENDED TOWING CAPACITY. *****

HAVING INSTALLATION QUESTIONS? CALL TECHNICAL SUPPORT AT 1-800-798-0813

INSTALLATION STEPS

NOTE: (Steps 1 & 16-18 are for 2010 models only. All other model years skip to step 2)

1. Remove air dam and plastic grill panel by removing (7) plastic fasteners, (3) bolts, and (6) clips. If vehicle is equipped with factory installed tow hooks skip to step 3 (no hole enlargement required). If no tow hooks are present and hole enlargement is preferred skip to step 11.

2. Remove air dam by removing (5) plastic fasteners. If optional trimming is selected this will occur in step 21.

NOTE: (Steps 3-10 & 16-17 are for models equipped with factory installed tow hooks and no hole enlargement is required. If hole enlargement is preferred on vehicles without tow hooks skip to step 11)

3. Take off vehicle grill by removing (6) plastic fasteners.

4. Begin the removal of front bumper cover by first removing the (3) lower screws from the bottom of bumper.

5. Remove the (5) plastic fasteners from top of bumper cover.

6. Continue bumper cover removal by removing (2) plastic fasteners and (1) socket screw in each wheel well.

7. Carefully pull bumper cover away from frame. Twist and remove head light lamps from their housing units. Place bumper cover off to the side.

8. Remove factory tow hooks and lock nuts. These will not be reinstalled, return to vehicle owner.

9. Remove the front frame end caps to allow removal of factory installed tow hook hardware.

10. Fishwire (2) carriage bolts and spacers through the front of each frame rail, as shown on page 1.

NOTE: (Steps 11-13 are for the hole enlargement option)

11. Enlarge the square mounting holes on each frame rail so the included 1/2" hardware can pass through.

12. Fishwire 1/2" carriage bolt and CM-SP17 spacer into front mounting hole on each side.
(See FISHWIRE TECHNIQUE on page 1)

13. Reverse fishwire 1/2" carriage bolt and CM-SP17 spacer into rear mounting hole on each side.
(See REVERSE PULL FISHWIRE TECHNIQUE on page 1)

14. Using the fishwires on the carriage bolts as a guide raise hitch into position. (Rubber guards will need to be temporarily flipped out of the way on 2010 models) Remove the fishwires and secure with flange nuts.

15. Torque all 1/2" hardware to 75 ft-lbs.

16. On 2010 models, trim fascia so it is able to be fastened back onto vehicle cross member. (See FASCIA in TRIM DIAGRAM (2010 MODELS ONLY) on page 1) Trim dimensions are approximate.

17. If removed in step 1, reinstall plastic grill panel.

18. If removed in step 1, raise air dam into position and mark location to trim for receiver tube. After hole is trimmed for the receiver tube raise air dam back into position and mark trim locations for the hitch chain loops (See AIR DAM in TRIM DIAGRAM (2010 MODELS ONLY) on page 1) Trim dimensions are approximate. Check fit prior to trimming. Reinstall air dam.

19. If removed in step 9, reinstall frame end caps.

20. If removed in steps 3-7, reinstall head lights, bumper cover and grill.

NOTE: (Air dam trimming option for 2005-2009 models)

21. Trim an approximate 2 5/8" square from the center bottom portion of air dam. (See TRIM DIAGRAM (2005-2009 MODELS ONLY) on page 1) Trim dimensions are approximate. Check fit prior to trimming. Reinstall air dam.

PERIODICALLY CHECK THIS RECEIVER HITCH TO ENSURE THAT ALL FASTENERS ARE TIGHT AND THAT ALL STRUCTURAL COMPONENTS ARE SOUND.

***DO NOT EXCEED VEHICLE MANUFACTURER'S RECOMMENDED TOWING CAPACITY ***.

FRONT MOUNTED ACCESSORIES

1) Do not exceed front axle Gross Weight Rating (GAWR). Consult owners manual or specification plate located on driver's door frame. Measure gross front axle weight by placing front wheels of loaded vehicle on a scale.

WARNING: Exceeding GAWR may overload the front axle and/or suspension. This could result in **accident, property damage and personal injury.**

2) Reposition front mounted license plate if obstructed.

3) Do not obstruct vehicle lights.

4) Allow free air flow into grille opening.

5) Rear wheel traction may be reduced. This could effect handling. Reduce speed and drive with caution.

6) Accessories extend front of vehicle. This may reduce approach angle. Use caution when parking and maneuvering.

7) Do not obstruct driver view.

VEHICLE RECOVERY AND WINCHING TIPS

1) Use OEM tow hooks, recovery eyes or a clevis mount for attachment of a tow strap or winch cable.

WARNING: NEVER use a ball and/or ball mount as an anchor point for tow strap or winch cable. Severe personal injury or death could result.

2) Observe winch manufacturer's recommendations, cautions and warnings.

3) Attach return cable to tow hook or recovery eye when using a snatch block (See figure 1).

CAUTION: Do not attach return cable to winch mount. This may overload winch mount and/or front mounted receiver.

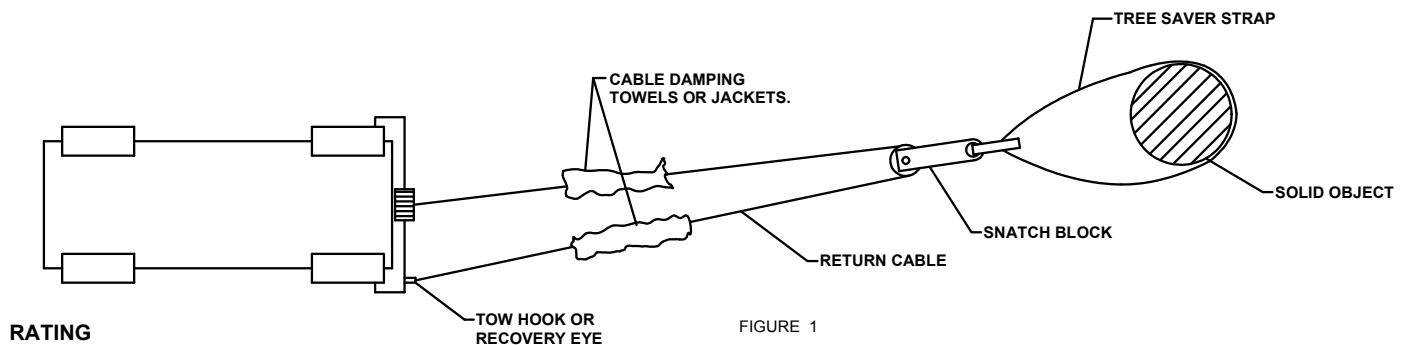

RATING

For **Maximum** line pull rating, winch cable must not exceed:

- 15 degree angle up or down from horizontal (See Figure 2).
- 45 degree angle left or right from straight ahead (See Figure 3).

CAUTION: Exceeding the maximum line pull rating may over load winch, winch mount, and/or front mounted receiver.

