

LoadLIFTER 5000

by AIR LIFT®

Kit 57286

*2001- Chevrolet Silverado/
GMC Sierra 3500 Commercial
Cab and Chassis*

rear application

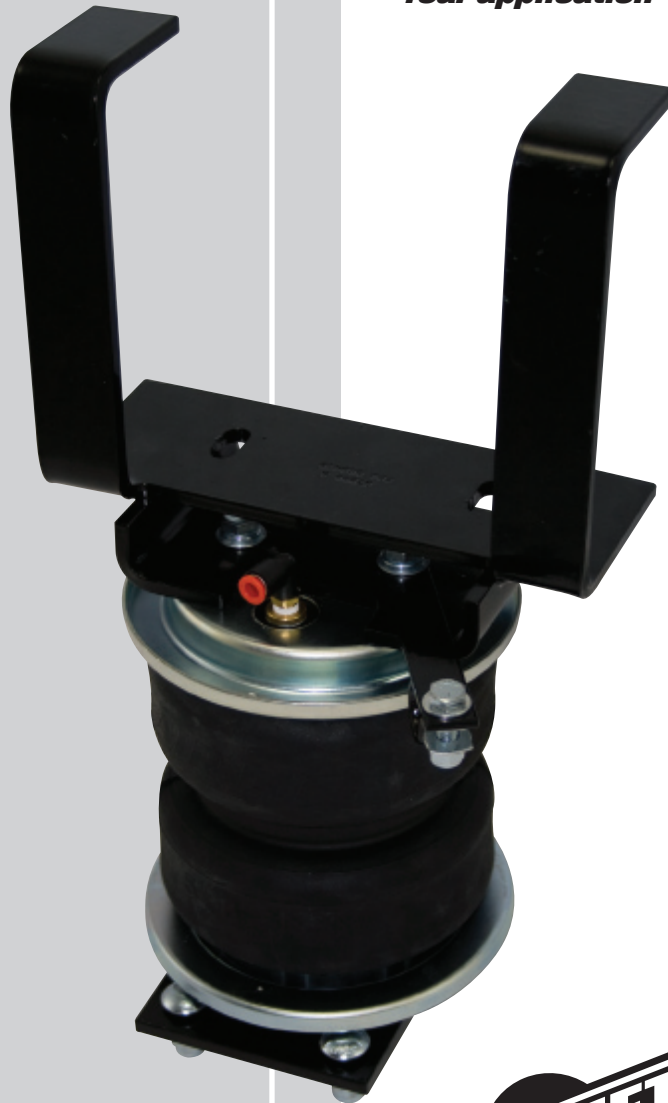

INSTALLATION GUIDE

For maximum effectiveness and safety, please read these instructions completely before proceeding with installation.

Failure to read these instructions can result in an incorrect installation.

TABLE OF CONTENTS

Introduction	2
Important Safety Notice	2
Notation Explanation	2
Installation Diagram	3
Hardware List	4
Tools List	4
Installing the LoadLifter 5000 System	5
Getting Started	5
Assembling the Air Spring	5
Setting the Assembly in Place	6
Securing the Emergency Brake Cable	9
Installing the Air Lines	10
Installing the Heat Shield	11
Checking for Leaks	11
Fixing Leaks	12
Before Operating	13
Installation Checklist	13
Post-Installation Checklist	13
Product Use, Maintenance and Servicing	13
Suggested Driving and Maximum Pressure	13
Maintenance Guidelines	14
Troubleshooting Guide	14
Frequently Asked Questions	15
Tuning the Air Pressure	15
Guidelines for Adding Air	16
Replacement Information	16
Contact Information	16
Warranty and Return Policy	17

Introduction

The purpose of this publication is to assist with the installation, maintenance and troubleshooting of the LoadLifter 5000 air spring kit. LoadLifter 5000 utilizes sturdy, reinforced, commercial grade single or double, depending on the kit, convolute bellows. The bellows are manufactured like a tire with layers of rubber and cords that control growth. LoadLifter 5000 kits are recommended for most 3/4 and 1 ton pickups and SUVs with leaf springs and provide up to 5,000 lbs. of load leveling support with air adjustability from 5-100 PSI. The kits are also used in motor home rear kits and some motor home fronts where leaf spring are used.

It is important to read and understand the entire installation guide before beginning installation or performing any maintenance, service or repair. The information here includes a hardware list, tool list, step-by-step installation information, maintenance guidelines and operating tips.

Air Lift Company reserves the right to make changes and improvements to its products and publications at any time. For the latest version of this manual, contact Air Lift Company at (800) 248-0892 or visit our website at www.airliftcompany.com.

IMPORTANT SAFETY NOTICE

The installation of this kit does not alter the Gross Vehicle Weight Rating (GVWR) or payload of the vehicle. Check your vehicle's owner's manual and do not exceed the maximum load listed for your vehicle.

Gross Vehicle Weight Rating: The maximum allowable weight of the fully loaded vehicle (including passengers and cargo). This number — along with other weight limits, as well as tire, rim size and inflation pressure data — is shown on the vehicle's Safety Compliance Certification Label.

Payload: The combined, maximum allowable weight of cargo and passengers that the truck is designed to carry. Payload is GVWR minus the Base Curb Weight.

NOTATION EXPLANATION

Hazard notations appear in various locations in this publication. Information which is highlighted by one of these notations must be observed to help minimize risk of personal injury or possible improper installation which may render the vehicle unsafe. Notes are used to help emphasize areas of procedural importance and provide helpful suggestions. The following definitions explain the use of these notations as they appear throughout this guide.



DANGER

INDICATES IMMEDIATE HAZARDS WHICH WILL RESULT IN SEVERE PERSONAL INJURY OR DEATH.



WARNING

INDICATES HAZARDS OR UNSAFE PRACTICES WHICH COULD RESULT IN SEVERE PERSONAL INJURY OR DEATH.



CAUTION

INDICATES HAZARDS OR UNSAFE PRACTICES WHICH COULD RESULT IN DAMAGE TO THE MACHINE OR MINOR PERSONAL INJURY.

NOTE

Indicates a procedure, practice or hint which is important to highlight.

Installation Diagram

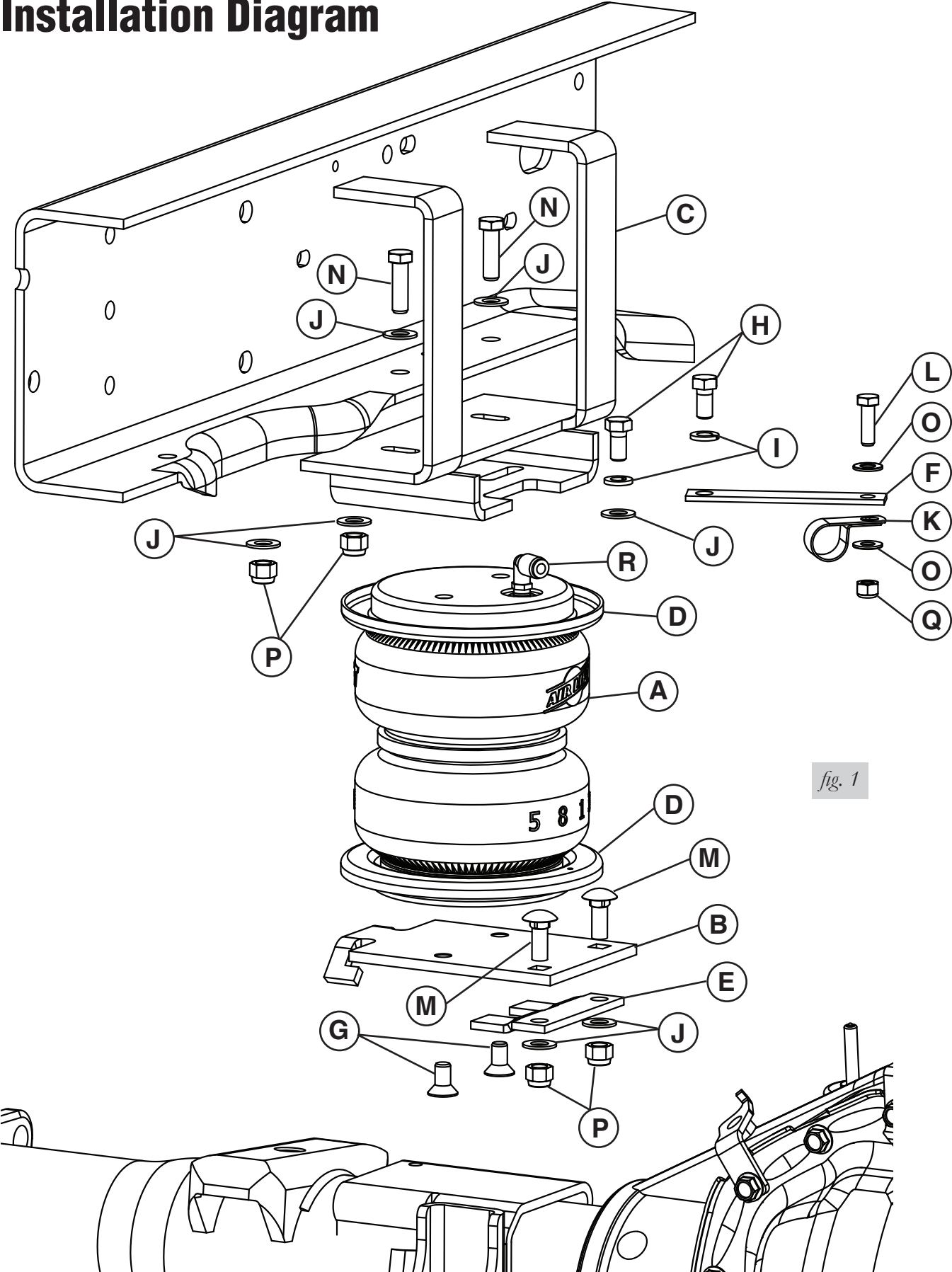

fig. 1

HARDWARE LIST

Item	Part #	Description	Qty
A	58437	Bellows.....	2
B	03253	Lower Bracket.....	2
C	07990	Upper Bracket.....	2
D	11951	Roll Plate.....	4
E	03267	Clamp.....	2
F	11041	Emergency Brake Cable Bracket.....	1
G	17215	3/8-24 x 3/4 Flat Head Screw	4
H	17203	3/8-24 x 7/8 Hex Cap Screw	4
I	18427	3/8" Lock Washer.....	4
J	18444	3/8" Flat Washer	15
K	10465	5/8" Clip.....	1
L	17103	5/16-18 x 1 Hex Cap Screw.....	1
M	17134	3/8-16 x 1 Carriage Bolt.....	4
N	17188	3/8-16 x 1.25 Hex Cap Screw	4
O	18433	5/16" Flat Washer	2
P	18435	3/8-16 Nyloc Nut	8
Q	18438	5/16-18 Nyloc Nut	1
R	21837	90° Swivel Elbow Fitting.....	2
S	20086	Air Line Assembly	1
T	10466	Tie Strap	6
U	18501	M8 Flat Washer.....	2
V	18411	Small Star Washer	2
W	21230	Valve Caps.....	2
X	21233	5/16-32 Hex Nut.....	4
Y	21234	Rubber Washer.....	2
Z	34365	Heat Shield	1

TOOLS LIST
Description

Safety Glasses
 Hoist or Floor Jack
 Jack Stands
 Standard & Metric Sockets and Wrenches
 Air Compressor or Compressed Air Source
 Spray Bottle with Dish Soap/Water Solution
 Hose Cutter, Razor Blade or Sharp Knife
 Drill and 5/16" Drill Bit



Missing or damaged parts? Call Air Lift customer service at (800) 248-0892 for a replacement part.

INSTALLING THE LOAD LIFTER 5000 SYSTEM

GETTING STARTED

1. Raise the vehicle and support the frame with jack stands. Lower the axle as far as it can go.
2. Remove the Jounce Bumpers from the frame that are above the axle.

ASSEMBLING THE AIR SPRING

1. Set the roll plates (D) on both sides of the Bellows (A). The radius (rounded edge) of the roll plate will be towards the air spring, so both ends are seated in both roll plates (fig. 1).
2. Install the 90° swivel elbow fitting (R) to the top of the bellows (A). Tighten finger tight plus 1 and a ½ turns. Be careful to only tighten on the hex nut. Do not over tighten.
3. Driver Side: install the upper bracket to the bellows assembly using two 3/8" bolts (H), lock washers (I), with one flat washers (J) on the rear bolt, and the Emergency Brake cable bracket (F) on the forward bolt (fig. 2). Leave bolts loose at this time.
4. Passenger Side: install the upper bracket to the bellows assembly using two 3/8" bolts (H), lock washers (I), flat washers (J). Leave the bolts loose at this time.

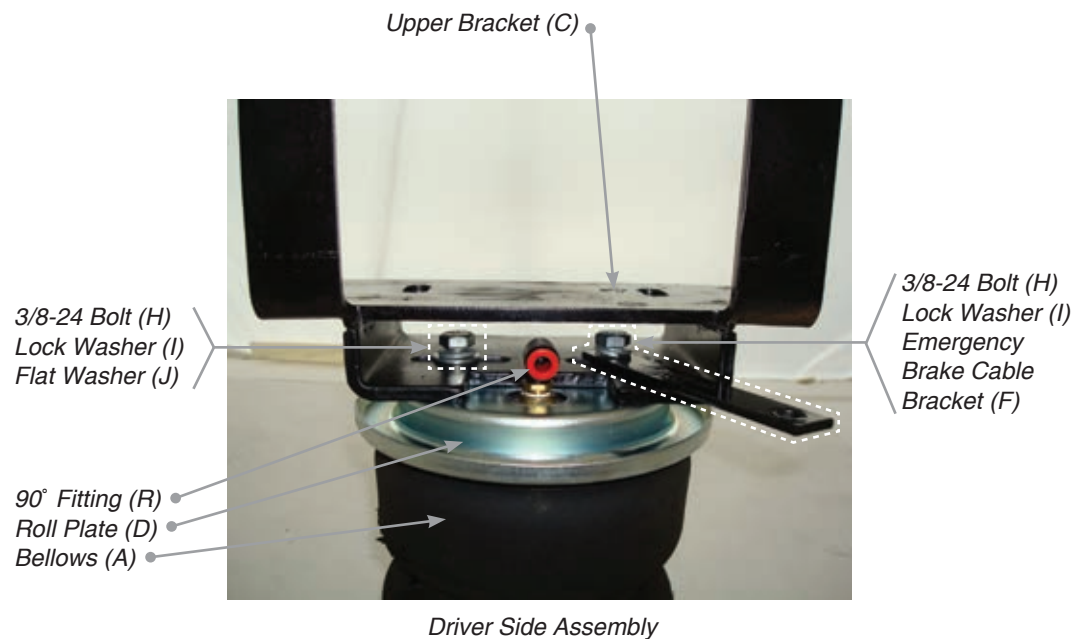
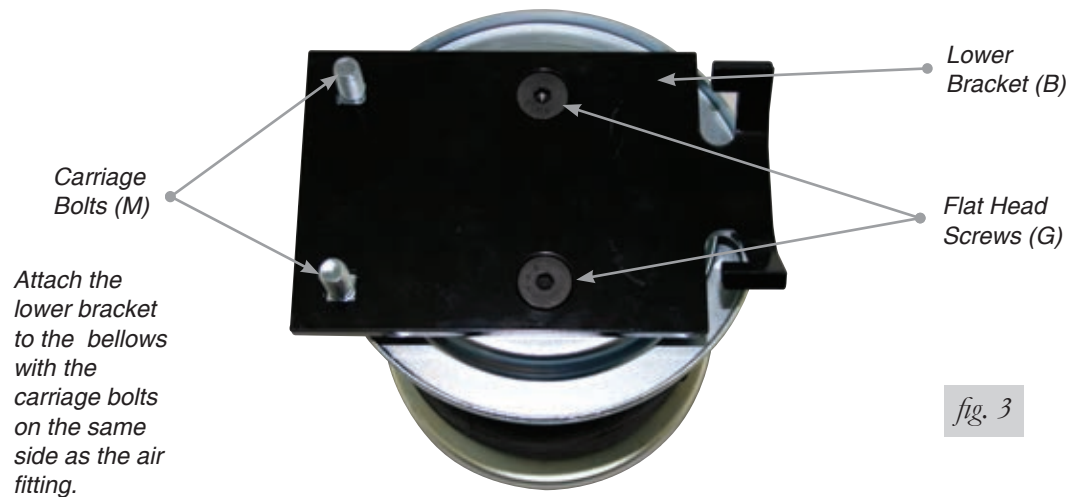

fig. 2

5. Insert two 3/8 carriage bolts (M) into the lower bracket (B) opposite end of the "tabs" that are on one end. Attach the lower bracket to the bellows assembly using two 3/8 Flat Head Screws (G) and tighten securely.

NOTE

The end with the carriage bolts in the lower bracket will be on the same side as the fitting (fig. 3).



SETTING THE ASSEMBLY IN PLACE

The assembly with the emergency brake cable bracket mounts on the driver side. Install both sides together throughout the installation (not one at a time).

1. Set the clamp (E) into position under the jounce bumper strike plate that is welded to the axle (fig. 4).

NOTE

It may be necessary to pry the bracket into position.

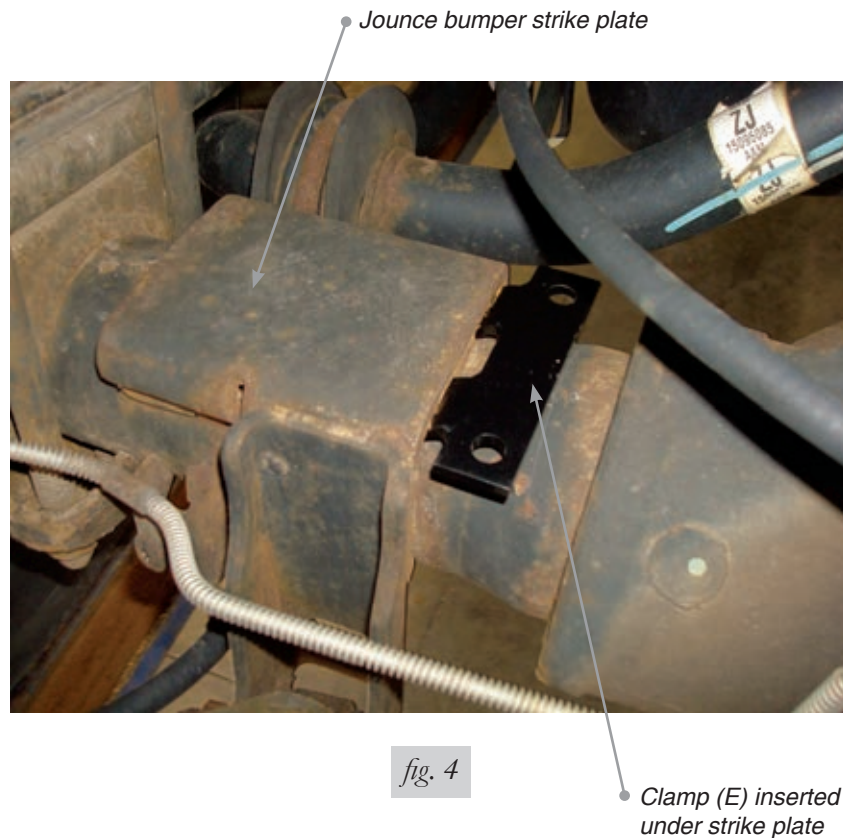

2. Set the driver side assembly in place over the axle. The “tabs” that are on the outside of the lower bracket will index under the jounce bumper strike plate (fig. 5).

NOTE

It may be necessary to pry the bracket into position.

Lower Bracket Tab inserted under jounce bumper strike plate that is welded to the axle.

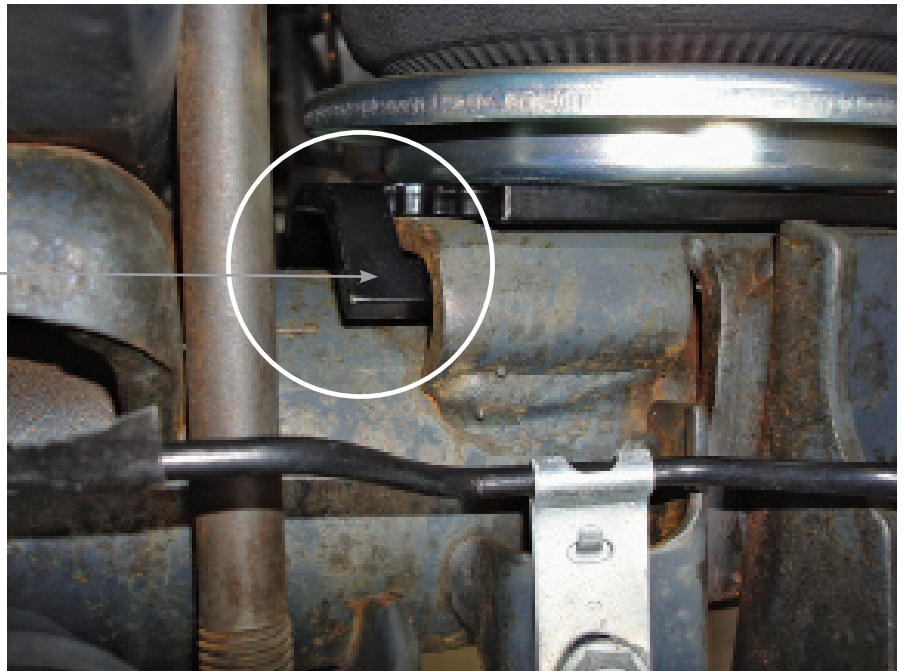

fig. 5

3. While setting the lower bracket into position, insert the lower bracket carriage bolts into the holes in the clamp (E). Cap with two 3/8 flat washers (J) and nyloc nuts (P) and tighten both nuts evenly until tight (fig. 6).

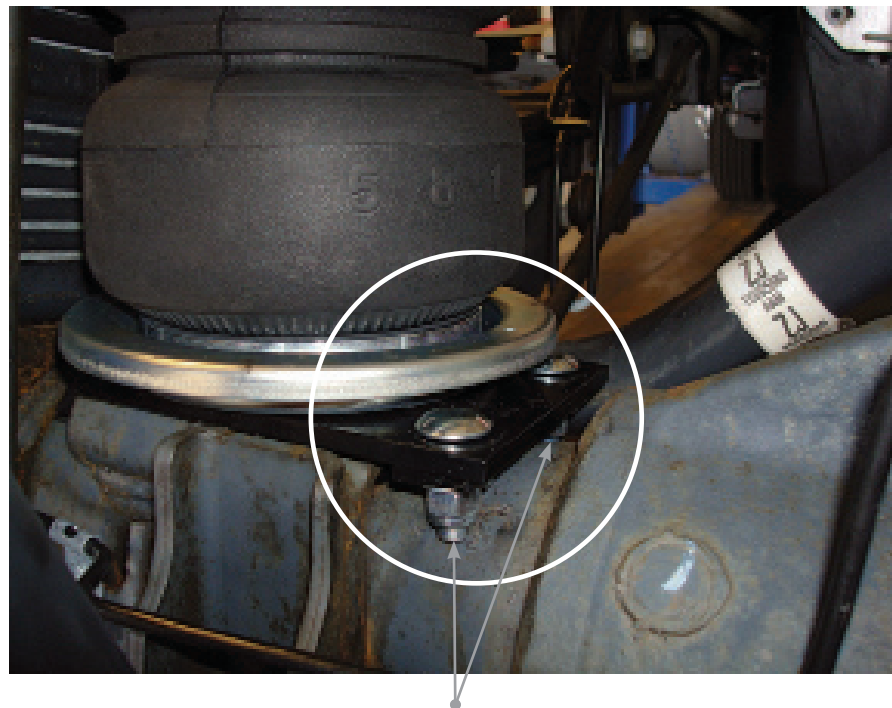

fig. 6

Carriage bolt from lower bracket through Clamp (E) and capped with Flat Washer (J) and Nyloc Nut (P). Tighten both nuts evenly until tight.

- The upper bracket will set under the bottom frame flange. Lift the axle up just far enough for the upper bracket to touch the frame.

NOTE

The upper brace also fits under the top flange of the frame (fig. 7).



fig. 7

- Using the existing holes that the jounce bumper was removed from, attach the upper bracket to the frame by using two 3/8 bolts (N) four flat washers (J) and nyloc nut (P).

NOTE

Set the nut inside, on the bracket while holding the washer onto the underside of the bolt. Push the bolt down into the nut, and then turn the bolt to get it to start. With the bellows mounting bolts still loose, it may be necessary push the bellows forward or back to gain clearance to start the nut (fig. 8).

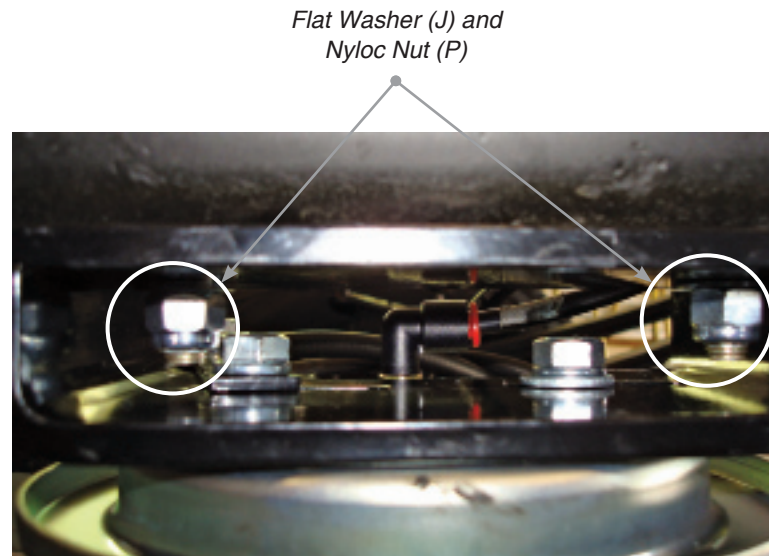

fig. 8

While holding the flat washer up on the bolt that is through the frame/bracket, set the nyloc nut in place on the bracket and slide it into position under the bolt. Push the bolt into the nyloc nut and turn the bolt to start it into the nut.

6. Align the bellows by moving the upper bracket inward or outward and by moving the bellows forward and back so that the bellows is perpendicular to both brackets. Then tighten the upper bracket mounting bolts to 31ftlbs.
7. Raise the suspension back up to stock ride height. Make sure bellows is still aligned. Push the emergency bracket (F), on the driver's side only, as far forward as possible and tighten the upper bellows mounting bolts securely. Do not over tighten.

SECURING THE EMERGENCY BRAKE CABLE

To keep the emergency brake cable from rubbing a hole in the side of the bellows, it will be necessary to secure it to the emergency brake cable mounting bracket.

1. Installing a clip (K) to the cable and attach the clip to the bracket using a 5/16 hex cap screw (L), two flat washers (O), and a nyloc nut (Q). Install the cable so it is on the bellows side of the mounting hardware (fig. 9).

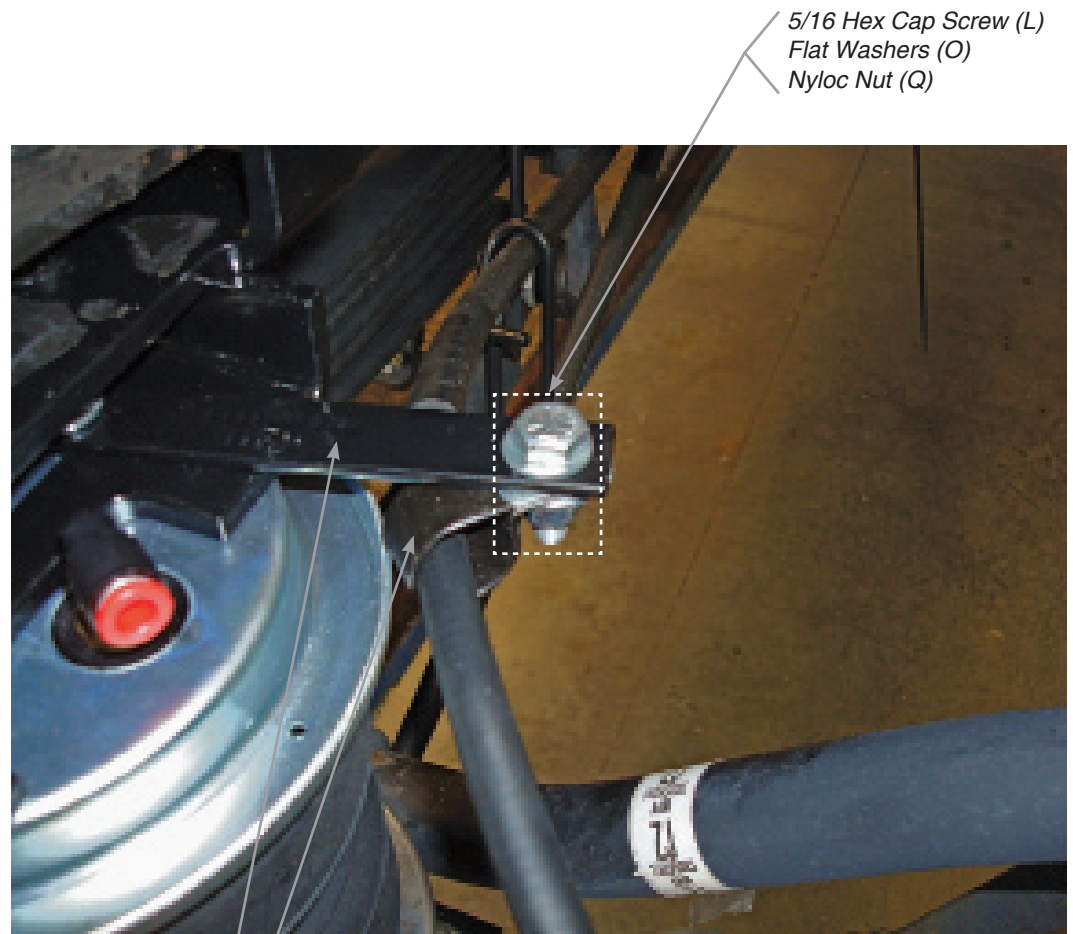

5/16 Hex Cap Screw (L)
 Flat Washers (O)
 Nyloc Nut (Q)

Emergency Brake
 Cable Bracket (F)

Clip (K)

fig. 9

Cable goes on the bellows side
 of the mounting hardware

INSTALLING THE AIR LINES

1. Choose a convenient location for mounting the inflation valves. Popular locations for the inflation valve are:
 - a. The wheel well flanges
 - b. The license plate recess in bumper
 - c. Under the gas cap access door
 - d. Through the license plate

NOTE

Whatever the chosen location, make sure there is enough clearance around the inflation valves for an air chuck.

2. Drill two 5/16" holes to install the inflation valves.
3. Cut the air line assembly in two equal lengths.

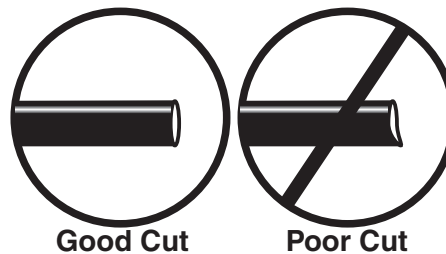

fig. 10

CAUTION

WHEN CUTTING OR TRIMMING THE AIR LINE, USE A HOSE CUTTER, A RAZOR BLADE, OR A SHARP KNIFE. A CLEAN, SQUARE CUT WILL ENSURE AGAINST LEAKS. DO NOT USE WIRE CUTTERS OR SCISSORS TO CUT THE AIR LINE. THESE TOOLS MAY FLATTEN OR CRIMP THE AIR LINE CAUSING IT TO LEAK AROUND THE O-RING SEAL INSIDE THE ELBOW FITTING (FIG. 10).

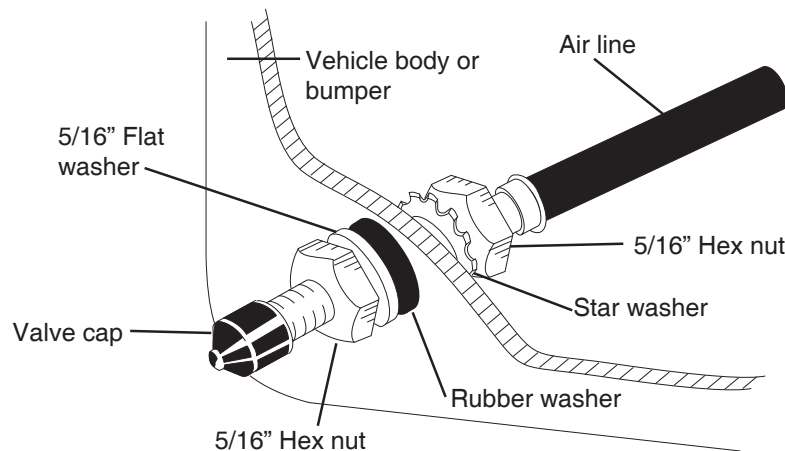

fig. 11

4. Place a 5/16" nut and star washer on the air valve. Leave enough of the inflation valve in front of the nut to extend through the hole and have room for the rubber washer, flat washer, and 5/16" nut and cap. There should be enough valve exposed after installation—approximately 1/2"—to easily apply a pressure gauge or an air chuck (fig. 11).
5. Push the inflation valve through the hole and use the rubber washer, flat washer, and another 5/16" nut to secure it in place. Tighten the nuts to secure the assembly.
6. Route the air line along the frame to the air fitting on the air spring (fig. 12). Keep AT LEAST 6" of clearance between the air line and heat sources, such as the exhaust pipes, muffler, or catalytic converter. Avoid sharp bends and edges. Use the plastic tie straps to secure the air line to fixed, non-moving points along the chassis. Be sure that the tie straps are tight, but do not pinch the air line. Leave at least 2" of slack to allow for any movement that might pull on the air line (fig. 12).

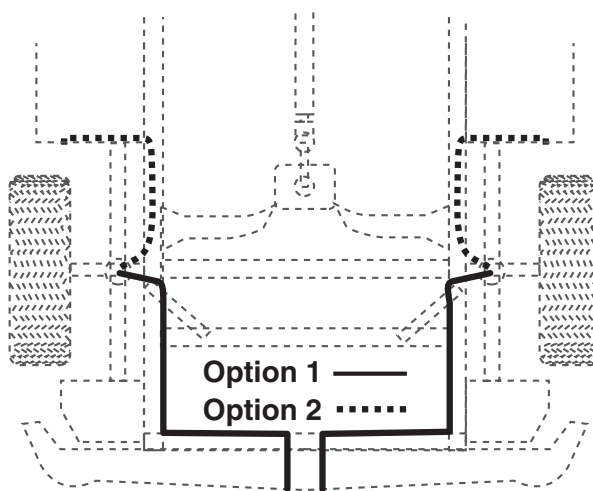

fig. 12

7. Cut off the air line, leaving approximately 12" of extra air line. A clean square cut will ensure against leaks. Insert the air line into the air fitting. This is a push-to-connect fitting. Simply push the air line into the 90° swivel fitting until it bottoms out (9/16" of air line should be in the fitting).
8. Install the minimum/maximum air pressure decal in a highly visible location. We suggest placing the decal on the driver-side window, just above the door handle.

INSTALLING THE HEAT SHIELD

1. Bend tabs to provide a 1/2" dead air space between exhaust pipe and heat shield (fig. 13).
2. Attach the heat shield to the exhaust pipe using the clamps. Bend the heat shield for maximum clearance to the air spring (fig. 13).

NOTE

If your model comes with an exhaust resonator near the installation location, you will need two 5.5" hose clamps to install the heat shield (fig. 13a).

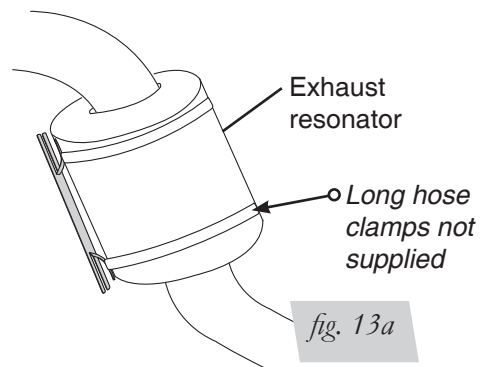
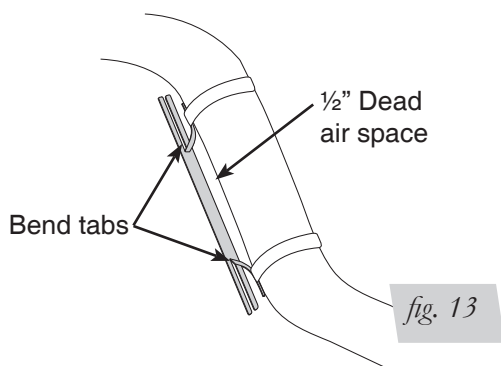

CHECKING FOR LEAKS

1. Inflate the air spring to 30 PSI.
2. Spray all connections and the inflation valves with a solution of 1/5 liquid dish soap and 4/5 water. Spot leaks easily by looking for bubbles in the soapy water.
3. After the test, deflate the springs to the minimum pressure required to restore the system to normal ride height. Do not deflate to lower than 5 PSI.
4. Check the air pressure again after 24 hours. A 2 - 4 PSI loss after initial installation is normal. Retest for leaks if the loss is more than 5 lbs.

FIXING LEAKS

1. If there is a problem with the swivel fitting:
 - a. Check the air line connection by deflating the spring and removing the line by pulling the collar against the fitting and pulling firmly on the air line. Trim 1" off the end of the air line. Be sure the cut is clean and square (see fig. 10). Reinsert the air line into the push-to-connect fitting.
 - b. Check the threaded connection by tightening the swivel fitting another ½ turn. If it still leaks, deflate the air spring, remove the fitting, and re-coat the threads with thread sealant. Reinstall by hand tightening as much as possible and then use a wrench for an additional two turns.
2. If there is a problem with the inflation valve:
 - a. Check the valve core by tightening it with a valve core tool.
 - b. Check the air line by removing the air line from the barbed type fitting. Cut the air line off a few inches in front of the fitting and use a pair of pliers or vice grips to pull/twist the air line off of the fitting.



CAUTION

DO NOT CUT OFF THE AIR LINE COMPLETELY AS THIS WILL USUALLY NICK THE BARB AND RENDER THE FITTING USELESS.

3. If the preceding steps have not resolved the problem, call Air Lift customer service at (800) 248-0892.

Before Operating

INSTALLATION CHECKLIST (To be completed by installer)

- Clearance test — Inflate the air springs to 60 PSI and ensure there is at least ½” clearance around each bellow, away from anything that might rub against them. Be sure to check the tire, brake drum, frame, shock absorbers and brake cables.
- Leak test before road test — Inflate the air springs to 60 PSI, check all connections for leaks with a soapy water solution. See page 11 for tips on how to spot leaks. All leaks must be eliminated before the vehicle is road tested.
- Heat test — Be sure there is sufficient clearance from any heat sources — at least 6” for air springs and air lines. If a heat shield was included in the kit, install it. If there is no heat shield, but one is required, call (800) 248-0892.
- Fastener test — Recheck all bolts for proper torque. Axle straps carriage bolt lock nuts should be torqued to 16 ft/lbs. Re-torque after 100 miles.
- Road test — The vehicle should be road tested after the preceding tests. Inflate the air springs to 25 PSI (50 PSI if the vehicle is loaded). Drive the vehicle 10 miles and recheck for clearance, loose fasteners and air leaks.
- Operating instructions — If professionally installed, the installer should review the operating instructions on page 14 with the owner. Be sure to provide the owner with all of the paperwork which came with the kit.

Technician’s Signature _____

Date _____

POST-INSTALLATION CHECKLIST

- Overnight leak down test — Recheck air pressure after the vehicle has been used for 24 hours. If the pressure has dropped more than 5 PSI, then there is a leak that must be fixed. Either fix the leak yourself or return to the installer for service.
- Air pressure requirements — I understand the air pressure requirements of my air spring system. Regardless of load, the air pressure should always be adjusted to maintain ride height at all times.
- Thirty day or 500 mile test — I understand that I must recheck the air spring system after 30 days or 500 miles, whichever comes first. If any part shows signs of rubbing or abrasion, the source should be identified and moved, if possible. If it is not possible to relocate the cause of the abrasion, the air spring may need to be remounted. If professionally installed, the installer should be consulted. Check all fasteners for tightness.

Product Use, Maintenance and Servicing

Suggested Driving Pressure	Maximum Air Pressure
5 PSI	100 PSI
FAILURE TO MAINTAIN CORRECT MINIMUM PRESSURE (OR PRESSURE PROPORTIONAL TO LOAD), BOTTOMING OUT, OVER-EXTENSION OR RUBBING AGAINST ANOTHER COMPONENT WILL VOID THE WARRANTY.	

MAINTENANCE GUIDELINES

NOTE

By following the steps below, vehicle owners will obtain the longest life and best results from their air springs.

1. Check the air pressure weekly.
2. Always maintain normal ride height. Never inflate beyond 100 PSI.
3. If you develop an air leak in the system, use a soapy water solution (1/5 liquid dish soap and 4/5 water) to check all air line connections and the inflation valve core before deflating and removing the air spring.

CAUTION

FOR YOUR SAFETY AND TO PREVENT POSSIBLE DAMAGE TO YOUR VEHICLE, DO NOT EXCEED MAXIMUM GROSS VEHICLE WEIGHT RATING (GVWR), AS INDICATED BY THE VEHICLE MANUFACTURER. ALTHOUGH YOUR AIR SPRINGS ARE RATED AT A MAXIMUM INFLATION PRESSURE OF 100 P.S.I., THE AIR PRESSURE ACTUALLY NEEDED IS DEPENDANT ON YOUR LOAD AND GVWR.

4. Loaded vehicles require at least 25 PSI or more. A “loaded vehicle” refers to a vehicle with a heavy bed load, a trailer, or both. As discussed above, never exceed GVWR, regardless of air spring, air pressure, or other load assist. The springs in this kit will support approximately 40 lbs. of load (combined on both springs) for each 1 PSI of pressure. The required air pressure will vary depending on the state of the original suspension. Operating the vehicle below the minimum air spring pressure will void the Air Lift warranty.
5. When increasing load, always adjust the air pressure to maintain the normal ride height. Increase or decrease pressure from the system as necessary to attain normal ride height for optimal ride and handling. Remember that loads carried behind the axle (including tongue loads) require more leveling force (pressure) than those carried directly over the axle.
6. Always add air to springs in small quantities, checking the pressure frequently.
7. Should it become necessary to raise the vehicle by the frame, make sure the system is at minimum pressure (5 PSI) to reduce the tension on the suspension/brake components. Use of on board leveling systems do not require deflation or disconnection.
8. Periodically check the air spring system fasteners for tightness. Also, check the air springs for any signs of rubbing. Realign if necessary.
9. On occasion, give the air springs a hard spray with a garden hose in order to remove mud, sand, gravel or other abrasive debris.

Troubleshooting Guide

1. Leak test the air line connections, the threaded connection into the air spring, and all fittings in the control system.
2. Inspect the air lines to be sure none are pinched. Tie straps may be too tight. Loosen or replace the strap and replace leaking components.
3. Inspect the air line for holes and cracks. Replace as needed.
4. Look for a kink or fold in the air line. Reroute as needed.

If the preceding steps do not solve the problem, it is possibly caused by a failed air spring — either a factory defect or an operating problem. Please call Air Lift at (800) 248-0892 for assistance.

Frequently Asked Questions

Q. Will installing air springs increase the weight ratings of a vehicle?

No. Adding air springs will not change the weight ratings (GAWR, GCWR and/or GVWR) of a vehicle. Exceeding the GVWR is dangerous and voids the Air Lift warranty.

Q. Is it necessary to keep air in the air springs at all times and how much pressure will they need?

The minimum air pressure should be maintained at all times. The minimum air pressure keeps the air spring in shape, ensuring that it will move throughout its travel without rubbing or wearing on itself.

Q. Is it necessary to add a compressor system to the air springs?

No. Air pressure can be adjusted with any type of compressor as long as it can produce sufficient pressure to service the springs. Even a bicycle tire pump can be used, but it's a lot of work.

Q. How long should air springs last?

If the air springs are properly installed and maintained they can last indefinitely.

Q. Will raising the vehicle on a hoist for service work damage the air springs?

No. The vehicle can be lifted on a hoist for short-term service work such as tire rotation or oil changes. However, if the vehicle will be on the hoist for a prolonged period of time, support the axle with jack stands in order to take the tension off of the air springs.

Tuning the Air Pressure

Pressure determination comes down to three things — level vehicle, ride comfort, and stability.

1. Level vehicle

If the vehicle's headlights are shining into the trees or the vehicle is leaning to one side, then it is not level (fig. 14). Raise the air pressure to correct either of these problems and level the vehicle.

2. Ride comfort

If the vehicle has a rough or harsh ride it may be due to either too much pressure or not enough (fig. 15). Try different pressures to determine the best ride comfort.

3. Stability

Stability translates into safety and should be the priority, meaning the driver may need to sacrifice a perfectly level and comfortable ride. Stability issues include roll control, bounce, dive during braking and sponginess (fig. 16). Tuning out these problems usually requires an increase in pressure.



fig. 14

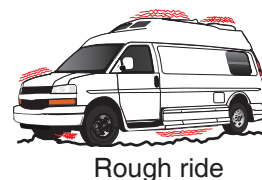

fig. 15



fig. 16

Guidelines for Adding Air

1. Start with the vehicle level or slightly above.
2. When in doubt, always add air.
3. For motorhomes, start with 50-100 PSI in the rear because it can be safely assumed that it is heavily loaded.
4. If the front of the vehicle dives while braking, increase the pressure in the front air bags, if equipped.
5. If it is ever suspected that the air bags have bottomed out, increase the pressure (fig. 17).
6. Adjust the pressure up and down to find the best ride.
7. If the vehicle rocks and rolls, adjust the air pressure to reduce movement.
8. It may be necessary to maintain different pressures on each side of the vehicle. Loads such as water, fuel, and appliances will cause the vehicle to be heavier on one side (fig. 18). As much as a 50 PSI difference is not uncommon.



Bottoming out

fig. 17

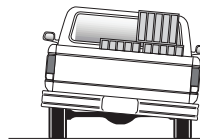

Unlevel

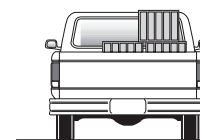

Level

fig. 18

Replacement Information

If you need replacement parts, contact the local dealer or call Air Lift customer service at (800) 248-0892. Most parts are immediately available and can be shipped the same day.

Contact Air Lift Company customer service at (800) 248-0892, first if:

- Parts are missing from the kit.
- Need technical assistance on installation or operation.
- Broken or defective parts in the kit.
- Wrong parts in the kit.
- Have a warranty claim or question.

Contact the retailer where the kit was purchased:

- If it is necessary to return or exchange the kit for any reason.
- If there is a problem with shipping if shipped from the retailer.
- If there is a problem with the price.

Contact Information

If you have any questions, comments or need technical assistance, contact our customer service department by calling (800) 248-0892, Monday through Friday, 8 a.m. to 5 p.m. Eastern Time. For calls from outside the USA or Canada, our local number is (517) 322-2144.

For inquiries by mail, our address is PO Box 80167, Lansing, MI 48908-0167. Our shipping address for returns is 2727 Snow Road, Lansing, MI 48917.

You may also contact us anytime by e-mail at sales@airliftcompany.com or on the web at www.airliftcompany.com.



Warranty and Returns Policy

Air Lift Company warrants its products, for the time periods listed below, to the original retail purchaser against manufacturing defects when used on catalog-listed applications on cars, vans, light trucks and motorhomes under normal operating conditions for as long as Air Lift manufactures the product. The warranty does not apply to products that have been improperly applied, improperly installed, used in racing or off-road applications, used for commercial purposes, or which have not been maintained in accordance with installation instructions furnished with all products. The consumer will be responsible for removing (labor charges) the defective product from the vehicle and returning it, transportation costs prepaid, to the dealer from which it was purchased or to Air Lift Company for verification.

Air Lift will repair or replace, at its option, defective products or components. A minimum \$10.00 shipping and handling charge will apply to all warranty claims. Before returning any defective product, you must call Air Lift at (800) 248-0892 in the U.S. and Canada (elsewhere, (517) 322-2144) for a Returned Materials Authorization (RMA) number. Returns to Air Lift can be sent to: Air Lift Company • 2727 Snow Road • Lansing, MI • 48917.

Product failures resulting from abnormal use or misuse are excluded from this warranty. The loss of use of the product, loss of time, inconvenience, commercial loss or consequential damages is not covered. The consumer is responsible for installation/reinstallation (labor charges) of the product. Air Lift Company reserves the right to change the design of any product without assuming any obligation to modify any product previously manufactured.

This warranty gives you specific legal rights and you may also have other rights that vary from state-to-state. Some states do not allow limitations on how long an implied warranty lasts or allow the exclusion or limitation of incidental or consequential damages. The above limitation or exclusion may not apply to you. There are no warranties, expressed or implied including any implied warranties of merchantability and fitness, which extend beyond this warranty period. There are no warranties that extend beyond the description on the face hereof. Seller disclaims the implied warranty of merchantability. (Dated proof of purchase required.)

Air Lift 1000	Lifetime Limited	Load Controller (I)	2 Year Limited
RideControl	Lifetime Limited	Load Controller (II)	2 Year Limited
SlamAir	Lifetime Limited	SmartAir	2 Year Limited
LoadLifter 5000*	Lifetime Limited	Wireless AIR	2 Year Limited
Lifestyle Systems**	1 Year Limited	Other Accessories	2 Year Limited

**formerly SuperDuty*
***formerly EasyStreet*

Need Help?

Contact our customer service department by calling (800) 248-0892, Monday through Friday, 8 a.m. to 7 p.m. Eastern Time. For calls from outside the USA or Canada, our local number is (517) 322-2144.

**Register your warranty online at
www.airliftcompany.com/warranty**



Thank you for purchasing Air Lift products — the professional installer's choice!

Air Lift Company • 2727 Snow Road • Lansing, MI 48917 or PO Box 80167 • Lansing, MI 48908-0167
Toll Free (800) 248-0892 • Local (517) 322-2144 • Fax (517) 322-0240 • www.airliftcompany.com

Printed in
the USA