



**OVER 35 YEARS OF INNOVATION, QUALITY, SAFETY.**  
**IMPORTANT OWNER-OPERATOR INSTALLATION INSTRUCTIONS**

**C3216**



REVISED version v6 BY: JL 8-6-2015  
**TECH SUPPORT (800) 246-8132**

**AFTER INSTALL, PLEASE GIVE  
THIS BOOKLET TO YOUR CUSTOMER**

# Warnings

## Truck Bed and Camper Protection

Torklift **does not** recommend installing your camper on top of a plastic bed liner (or other compressible material such as foam). These materials can act as a spring, causing increased vertical truck camper movement independent of the vehicle. Plastic bed liners can slide on the truck bed surface, and the truck camper can slide on top of the bed liner. Using a plastic bed liner or similar compressible material will void your warranty and may additionally cause truck bed and/or camper damage.











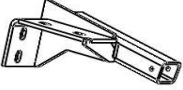
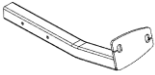

Minor movement or settling can occur in some incidental harsh driving conditions (on or off-road). A rubber bed mat is recommended to protect the truck bed and camper, but is not a requirement to maintain the Torklift legendary lifetime warranty.

## Suspension

To significantly reduce body roll, sag and sway Torklift strongly recommends the StableLoad. Torklift International StableLoads improve safety, handling, and to help level your truck. More information can be found at ([www.Torklift.com/stableload](http://www.Torklift.com/stableload)).

If your truck is additionally equipped with suspension air bags Torklift cautions against over pressurization as this may lead to unsafe vehicle handling characteristics. We have found that airbags used in conjunction with StableLoads have allowed operators to lower air bag pressure by 50% or more. Only pressurize suspension air bags enough to level the truck.

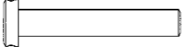
## Included Parts

	Tie Down Receiver	X2
	Bent Tie Down Insert	X2
	7/16" USS Flat Washer	4
	7/16" Lock Washer	4
	7/16" -14 x 1-1/2" Grade 8 Hex Bolt	4
	7/16" -14 Grade 8 Hex Nut	4
	1" x 2" Plate Washer	4
	1/2" Star Washer	4
	1/2" USS Flat Washer	8
	1/2" Lock Washer	4
	1/2" -13 x 1-1/2" Grade 8 Hex Bolt	4
	1/2" -13 Grade 8 Hex Nut	4
	Snapper Pin	2
	1/2" Bolt Fisher	1

*Note: On **Long Bed** Trucks the Tie Down Receiver is installed to the rear of the spring perch, while on **Short Bed** trucks the Tie Down Receiver is installed to the front of the spring perch.*

## Step 1

Starting on the passenger side, locate the rear leaf spring perch. Take one **7/16"-14 x 1-1/2" Grade 8 Bolt** with one **1/2" Star Washer** followed by one **1" x 2" Plate Washer**. Attach this Bolt assembly onto the Bolt Fisher. See Figure 1.1 for reference.

**Figure 1.1** - Bolt Assembly Order.

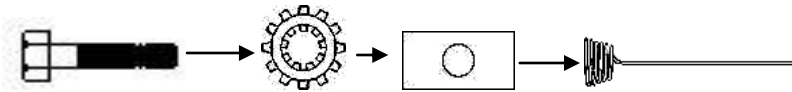

## Step 2

Fish the Bolt assembly **AS ONE UNIT** into the large hole on the backside of the spring perch and through the outside hole on the spring perch see photo 2.1 and 2.2.

**Photo 2.1**

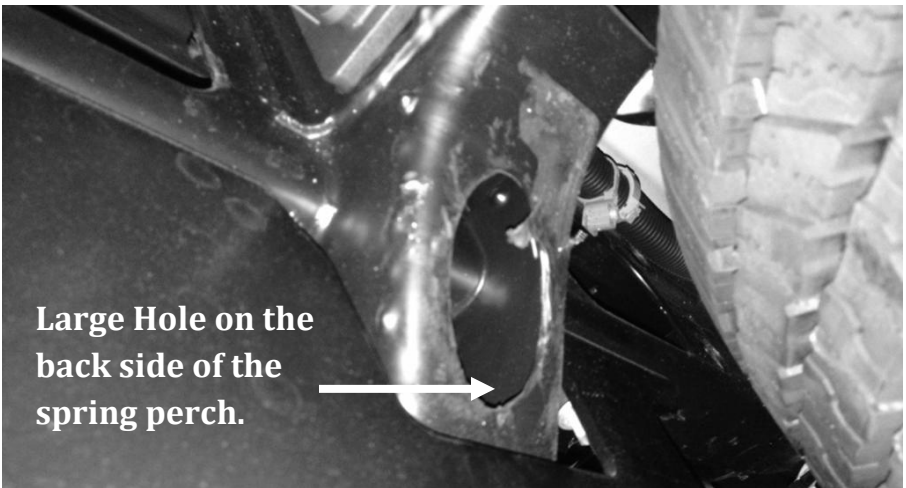

## Photo 2.2

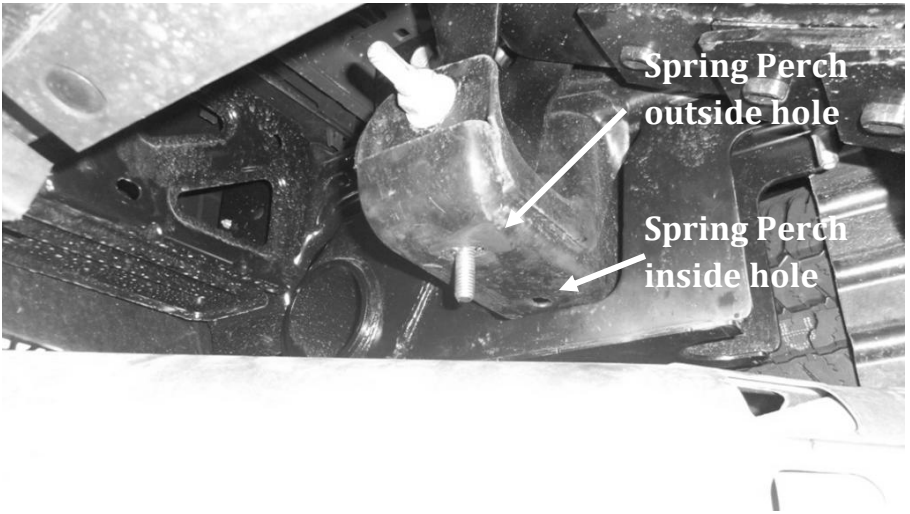

### Step 3

Repeat steps 1 and step 2 for the inside hole.

### Step 4

Slide the **Tie Down Receiver** over the exhaust and align the top slots with the **7/16"-14 x 1-1/2" Grade 8 Bolt** hanging from the Factory Spring Perch.

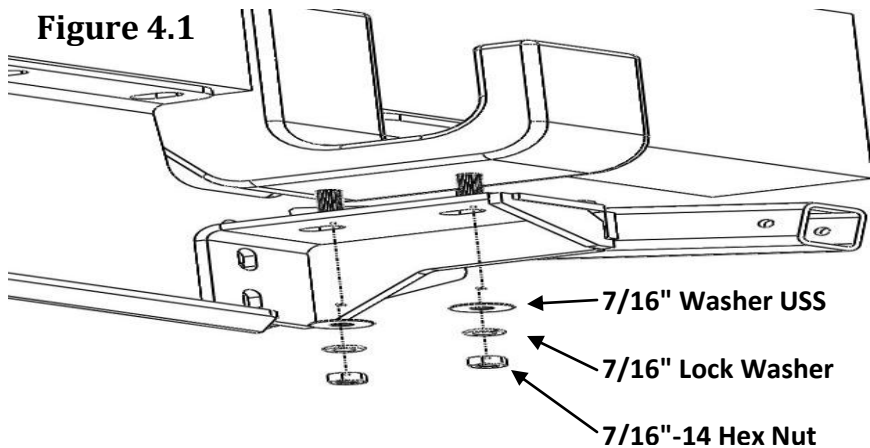

## Step 5

Secure the **Tie Down Receiver** to the spring perch by fastening one **7/16"** **Washer USS** followed by one **7/16"** **Lock Washer** and one **7/16"-14 Hex Nut** onto the **7/16"-14 x 1-1/2"** **Grade 8 Bolt**. Hand tighten see Figure 4.1 for reference.

## Step 6

With the **Tie Down Receiver** secured to the spring perch, run one **1/2"-13 x 1-1/2"** **Grade 8 Hex Bolt** with one **1/2"** **USS Flat Washer** through each slot on the **Super Hitch Side Plate** and out through the **Tie Down Receiver**.

## Step 7

Secure the **1/2"-13 x 1-1/2"** **Grade 8 Hex Bolt** and **1/2"** **USS Flat Washer** with one **1/2"** **USS Flat Washer**, followed by one **1/2"** **Lock Washer** and one **1/2"-13 Grade 8 Hex Nut**. Hand Tighten. See Figure 7.1.

**Figure 7.1**

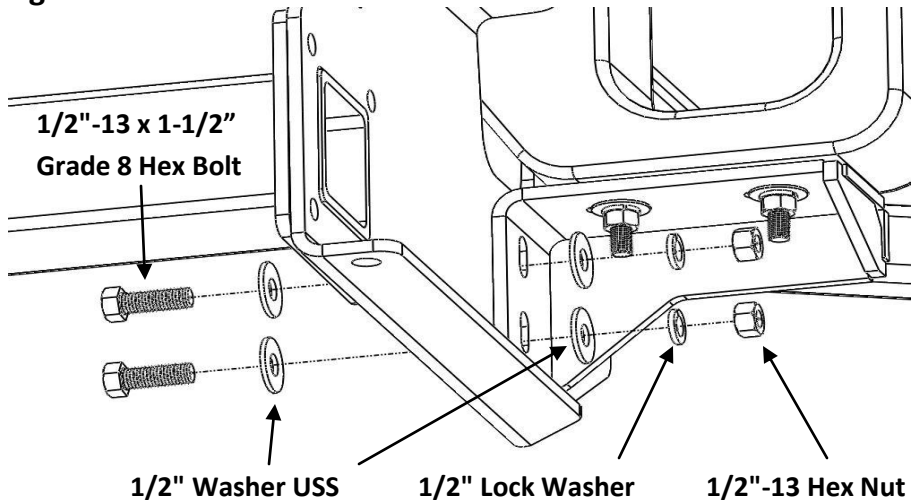

## Step 8

Torque all 1/2" hardware to **70 ft- lbs.**

Torque all 7/16" hardware to **60 ft-lbs.**

## Step 9

Install the **Tie Down Inserts** into the **Tie Down Receivers**. The plate on the end of the **Tie Down Inserts** should be offset towards the rear of the vehicle, with the mounting holes on the plate located above the tube.

Secure the **Tie Down Inserts** with a **Snapper Pin**. Either hole in the **Tie Down Insert** can be used as long as the turnbuckle has adequate clearance around the body of the truck.

***IMPORTANT NOTE: Your tie down inserts are designed to have clearance inside of the receiver. This is to account for road debris, as well as aid in installation and removal. Some rattle may be expected if the inserts are left installed while not under load from the camper.***

## RECOMMENDED TRUCK CAMPER INSTALLATION INSTRUCTIONS

When securing any heavy load (especially a camper) in your truck bed, your front tie down points should pull the load forward as much as possible. Some camper anchor points may differ with different manufacturers, as well as the camper jack mounting locations. Your Torklift tie down inserts have offset triangular brackets to increase the angle of pull. These are designed to be used in the front facing forward, and the rear facing rearward but can be used in either front or rear. These recommendations are to be considered and followed as a basic rule of thumb . Obviously there will be some applications where this may not be possible. At a minimum, if opposite pull of both front and rear Tiedowns cannot be achieved for whatever reason, you should have at least a forward pull at the front or rear location. If your camper does not come with Rubber Bumpers on the front lower portion of the camper, installing Rubber Bumpers (Torklift has Rubber Bumpers available Part A7001) or using a block of wood such as a 2 x 4 in the bed, will prevent the camper from damaging the front bulk head of the truck bed. Minor movement (or settling) can occur in some incidental harsh driving conditions (on or off road). A rubber bed mat is not a requirement to maintain the lifetime warranty on a Torklift system, but a strong recommendation simply as a safety precaution to protect the truck bed, the bottom of the camper and to give the camper additional support.

**TORKLIFT DOES NOT RECOMMEND:** Installing your truck camper in your truck on top of a drop in plastic bed liner!!! The drop in plastic bed liners can slide on top of the truck bed surface, and the camper can slide on top of the slick surface of the bed liner. The liner can also act as a spring causing a trampoline effect increasing vertical truck camper movement, independent of the vehicle, possibly resulting in truck bed, and camper damage!

## INSTRUCTIONS FOR FINISH MAINTENANCE OF TORKLIFT PRODUCTS

### POWDER COATED STEEL:

To keep your Torklift products looking good follow these guidelines. All steel powder coated Torklift products are sandblasted for maximum adhesion and use a high quality industrial urethane based powder coat. Due to the extreme, harsh, undercar environment that your Torklift products live in, (consistently sprayed with corrosive road chemicals such as salt, and road debris), Torklift does not warrant the power coated finish.

To minimize corrosion from these factors on powder coated steel products, Torklift recommends regularly cleaning and inspecting the powder coated surface and touching up any affected areas with an enamel or urethane based aerosol paint product. If there are any areas of surface rust, there are also aerosol spray rust converters available on the market that can be used as a preparation to touch-up paint application. These finish maintenance products are available at any automotive parts supplier.

### POLISHED STAINLESS STEEL :

TorkLift utilizes quality grade 304 stainless steel in our stainless steel polished products. 304 stainless steel is well known for its anti-corrosive properties. However, in some environments such as coastal regions or when coming in contact with some road chemicals, corrosion may occur. For a quick clean simply use WD40 and a cloth rag. We also recommend occasional polishing of our polished stainless products to maintain their attractive finish. Use an approved stainless steel chrome or aluminum mag wheel polish cleaning product which can be purchased from any automotive parts supplier.



## **Frame Mounted Tie Downs**

Leading the camper tie down industry in strength, quality, advanced design and installation. TorkLift TRUE frame mounted tie downs are far superior to all tie down systems available.

The TorkLift system is unique in its design and is patented. Four independent tie down points (with no belly or crossbar) working much like your receiver type trailer hitch as the inserts are removable allowing the system to be virtually undetectable when not in use. They are designed for each make and model to fit tight to the frame so as not to compromise ground clearance. Torklift tie downs are not universal ‘one size fits all’ therefore all the problems with correct fit for each particular application have been eliminated.

**VISIT [WWW.TORKLIFT.COM](http://WWW.TORKLIFT.COM) FOR MORE INFORMATION**

## **Original SuperHitch & SuperHitch Magnum**

High strength extended hitch system engineered for safely towing all types of trailers behind your truck and camper. With a max towing capacity of 14,000 lbs. with an extension\* , (17,000 lbs. to 20,000 lbs. without\*) the Original SuperHitch and Superhitch Magnum are rated the strongest in the industry.



**CONTACT YOUR LOCAL DEALER FOR MORE DETAILS**

# **Torklift International Limited Lifetime Warranty Information**

**322 Railroad Ave North, Kent, WA 98032**

Torklift will require proof of purchase to register, with pictures of any defective product before issuing a replacement. Torklift will not register any product without proof of purchase, which can be faxed, scanned, emailed, or mailed to the information provided below.

Torklift warrants it's hitches, custom hitch receivers, frame mounted tie downs, turnbuckles, and accessories (excluding wire harnesses which carry a 90 day warranty) from date of purchase against defects in material and workmanship under normal use and service for the ownership life of the original consumer purchaser. **ALL**

**COMMERCIAL APPLICATIONS ARE WARRANTED FOR A PERIOD OF 90 DAYS FROM THE DATE OF**

**INSTALLATION/SERVICE. Torklift will replace FREE OF CHARGE any part which proves defective in material or**

**workmanship when presented to Torklift, TRANSPORTATION CHARGES PREPAID by purchaser, at the address above. THIS WARRANTY IS LIMITED TO DEFECTIVE PARTS**

**REPLACEMENT ONLY. LABOR CHARGES AND/OR DAMAGE INCURRED IN INSTALLATION OR REPLACEMENT, AS WELL AS INCIDENTAL AND CONSEQUENTIAL DAMAGES CONNECTED THEREWITH ARE EXCLUDED. This warranty**

**does not include the finish or paint on our products. Rusting, cracking or peeling of the finish is also excluded. Some states do not allow the exclusion or limitation of incidental or consequential damages, so the above limitation or exclusion may not apply to you. Any damage to Torklift products as a result of misuse, abuse, neglect, accident, improper installation or any use violative of**

**instructions furnished by Torklift or WHEN USED IN ANY COMMERCIAL APPLICATION WILL VOID THE WARRANTY.**

**This warranty gives you specific legal rights, and you may also have rights which vary from state to state. With warranty service, you may be able to go to a small claims court, a state court or a federal district court.**



**322 Railroad Ave North, Kent, WA 98032**

**Phone (800) 246-8132 Fax (253) 854-8003**

**Or visit our website: [www.TorkLift.com](http://www.TorkLift.com)**

Dear Valued Customer,

Thank you for making TorkLift your choice for truck, camper packages and accessories for your vehicle. By choosing TorkLift products, you have chosen a company that has been serving the RV industry for nearly 40 years and whose name has become synonymous with strength, quality and advanced design and installation.

Please take a few moments of your time to complete the Product Registration Warranty Card on the next page. When registering your newly purchased TorkLift products, you can be assured that your contact information is secure and that you and your product are getting the attention and respect that you deserve.

Thank you again for choosing TorkLift quality products.

**Register for your lifetime warranty and receive a free Torklift International gift.**

To Fax: Send copies of the questionnaire, warranty card and receipt to  
253-854-8003

To E-mail: Send copies of the questionnaire, warranty card and receipt to  
[warranty@torklift.com](mailto:warranty@torklift.com)

To Mail: Send to Torklift International **322 Railroad Ave North, Kent, WA 98032**



**1. PART(S) PURCHASED**

TODAY'S DATE: \_\_\_\_\_

PART#: \_\_\_\_\_ PART#: \_\_\_\_\_  
PART#: \_\_\_\_\_ PART#: \_\_\_\_\_  
PART#: \_\_\_\_\_ PART#: \_\_\_\_\_

**2. PURCHASER INFORMATION**

NAME: \_\_\_\_\_  
ADDRESS: \_\_\_\_\_

CITY: \_\_\_\_\_ STATE: \_\_\_\_\_ ZIP / POSTAL CODE: \_\_\_\_\_  
PHONE: (\_\_\_\_) \_\_\_\_\_ - \_\_\_\_\_ EMAIL: \_\_\_\_\_

**3. TRUCK INFORMATION**

YEAR: \_\_\_\_\_ MAKE: \_\_\_\_\_  
MODEL: \_\_\_\_\_ BED LENGTH: \_\_\_\_\_

**4. CAMPER INFORMATION**

YEAR: \_\_\_\_\_ MAKE: \_\_\_\_\_ MODEL: \_\_\_\_\_

**5. DEALER INFORMATION**

PURCHASED FROM: \_\_\_\_\_  
ADDRESS: \_\_\_\_\_  
CITY: \_\_\_\_\_ STATE: \_\_\_\_\_ ZIP / POSTAL: \_\_\_\_\_  
INSTALLED BY:      OWNER      ABOVE DEALER      ANOTHER DEALER

IF ANOTHER DEALER, WHO: \_\_\_\_\_

**OFFICIAL WARRANTY REGISTRATION CARD**

PLEASE FILL OUT THIS FORM COMPLETELY AND RETURN TO TORKLIFT WITHIN

30 DAYS OF PURCHASE ACCOMPANIED BY A COPY OF YOUR ORIGINAL RECEIPT