

IMPORTANT:

The manufacturer is not responsible for negligent use of vehicle with mud flaps installed, including over-tightening of screws and bolts causing damage to vehicle or mud flaps.

TOOLS REQUIRED:

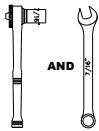

7/16" open wrench
and socket wrench

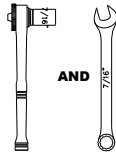

3/8" open wrench
and socket wrench

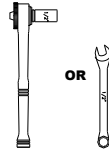

5/16" open wrench
or socket wrench



Slotted
Screw Driver

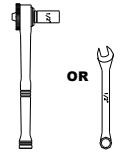

7/32" or 5.5mm open
or socket wrench
(truck w/o flare only)

BRACKETS

(2) Mount Bracket,
Front
Part #759521

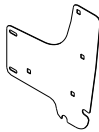

(1) Brace
Front, DS
Part # 759525

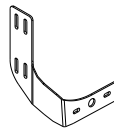

(1) Brace
Front, PS
Part # 759526

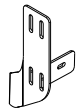

(1) Strip Washer
Front, DS
Part # 759508



Used for Rubber
Mud Flap
Installations Only.

(1) Strip Washer
Front, PS
Part # 759509



Used for Rubber
Mud Flap
Installations Only.

PARTS BAG #759523

a) (4) Capscrew, SS
1/4" - 20UNC x 1"
Part #014007



b) (6) Screw, Sheet Metal
SS, #12 x 1" HWH
Part # 010046



c) (4) Screw, Machine SS
M6-1x40mm, Hex Cap
Part # 012028



d) (2) Screw, Sheet Metal
SS, #12-11 x 3/4" HWH
Part # 010042



e) (16) Washer, Flat
Aluminum, 0.281" x 1"
Part #018052

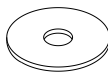

f) (10) Washer, Flat
SS, 0.281" x 1"
Part # 018028

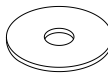

g) (8) Washer, Lock
SS, 1/4" Helicoil Spring
Part # 024000



h) (6) Washer, Nylon
1" OD x 0.318" ID
Part # 054061

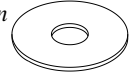

i) (4) Nut, Hex
SS, 1/4" - 20UNC
Part # 025000



j) (4) Nut, Hex
SS, M6-1
Part # 025022



k) (8) Nut, Expansion
Nylon, Natural #12
Part # 054059



*****Note*****

Aluminum Washer will appear duller and will be lighter in weight than the mirror finish stainless steel washers included.

*****Note*****

All Gatorback Mudflaps come with a hardware bag that, when using this bracket kit, can be disposed of. All hardware needed for this install is included with this bracket kit.

RUBBER FLAP INSTALLATION:

1. Start on driver side.
2. Cut the supplied full size template outline
3. Lay the cut template onto the front of the mud flap. (See diagram #2).
4. Cut the same size as the slotted holes on the template through the rubber flap.
5. Install the mud flap to the bracket with a strip washer, three sheet metal screws, three stainless steel washers, and three nylon washers. The top two holes of the strip washer use #12x1" screws and the bottom holes uses a #12 x 3/4" screw. Hole #3 uses a #12x1" screw with a stainless steel washer. Loosely secure at this point.
6. Square the flap with the tire while putting pressure against the wheel well and tighten all four sheet metal screws on the flap.
7. Repeat on passenger side.

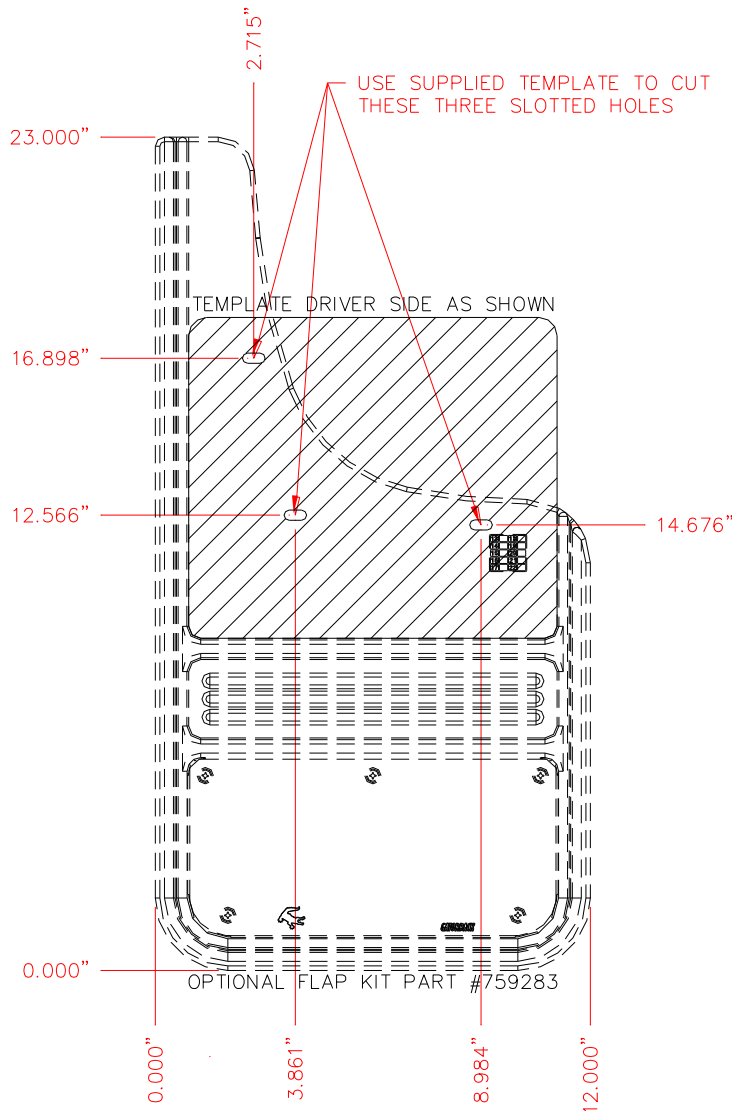

DIAGRAM # 2



For installation tutorial visit <https://www.truckhardware.ca/installation>

INSTALLATION OF BRACKET WITH FLARE ON RUBBER FLAPS ONLY:

For ease of installation, it is suggested that the wheel be removed.

1. Before you install your Mud Flap Bracket set, see the diagram and parts list for all necessary parts. Start on the driver's side.
2. Temporarily remove the factory plastic cap to get access to the two factory screws on the spring nuts #10 & #11, then remove the two factory screws and replace with four aluminum washers, two machine screws, two lock washers and two hex nuts through the back brace holes #12 & #13. Ensure the slotted holes of the back brace are mounted center of the machine screws.
3. Snap the expansion nuts into each square holes #4 to #7 on the bracket.
4. Tuck the bracket in between the wheel flare flange and the body wheel well and bolt the other end of the bracket holes #8 & #9 to the back brace holes #14 & #15 with four aluminum washers, two capscrews, two lock washers, and two hex nuts. (See diagram 1)

✓ Check all fasteners for tightness. Repeat procedure on the passenger side.

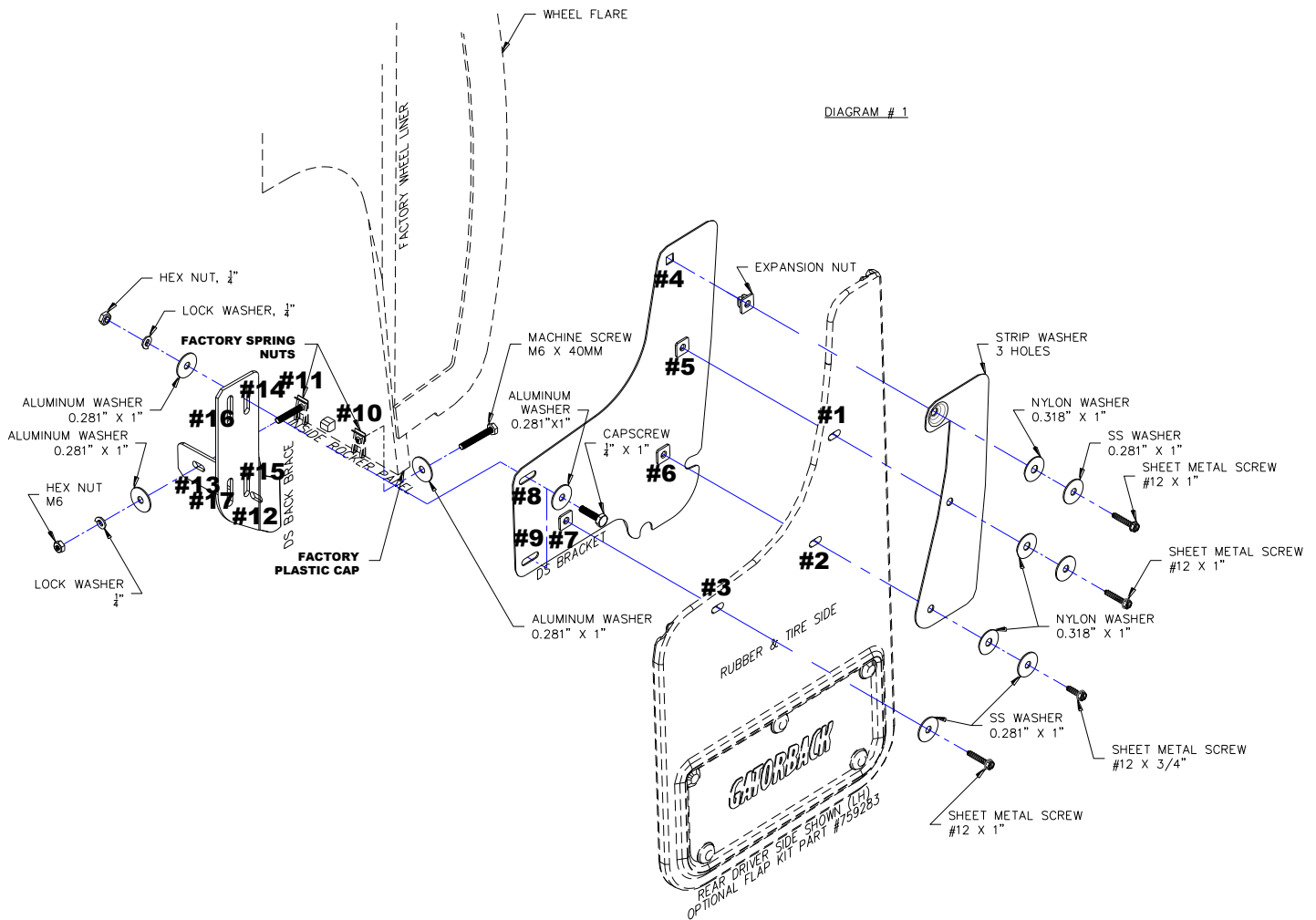

**** NOTICE ****

These instructions and enclosed parts have been provided in response to the Ford 2015 F150 SVE Bulletin. Any deviation of the installation and /or hardware may result in premature corrosion. The manufacturer and/or Dealer Distributor are not responsible for negligent use or installation.

STAINLESS STEEL FLAP INSTALLATION:

1. Before you install your Mud Flap set, see the diagram and parts list for all necessary parts. Cut the protective plastic and peel away from stainless steel. Start on the driver's side.
2. Cut the weather strip approximately 15" long and apply the adhesive side on the center of the wheel flare or wheel well and the same position as the mud flap panel where there is contact to the wheel flare or wheel well.
3. Install the mud flap to the bracket with four stainless steel washers and four sheet metal screws on holes #1 to #4 through the bracket holes #5 to #8. Loosely secure at this point.
4. Square the flap with the tire while putting pressure against the wheel flare or wheel well and tighten the four sheet metal screws on the stainless steel panel.

INSTALLATION OF BRACKET WITH FLARE ON STAINLESS STEEL OFFSET FLAPS ONLY:

For ease of installation, it is suggested that the wheel be removed.

1. Before you install your Mud Flap Bracket set, see the diagram and parts list for all necessary parts. Start on the driver's side.
2. Temporarily remove the factory plastic cap to get access to the two factory screws on the spring nuts #11 & #12 then remove the two factory screws and replace them with four aluminum washers, two machine screws M6x40mm, two lock washers and two hex nuts through the back brace hole #13 & #14. Ensure the slotted holes of the back brace are mounted center of the machine screws.
3. Snap the expansion nuts into each square holes #5 to #8 of the bracket.
4. Tuck the bracket in between the wheel flare flange and the body wheel well and the other end of the bracket holes #9 & #10 are bolted to the back brace holes #15 & #16 with four aluminum washers, two capscrews 1/4" x 1", two lock washers and two hex nuts (See Diagram)

✓ Check all fasteners for tightness. Repeat procedure on the passenger side.

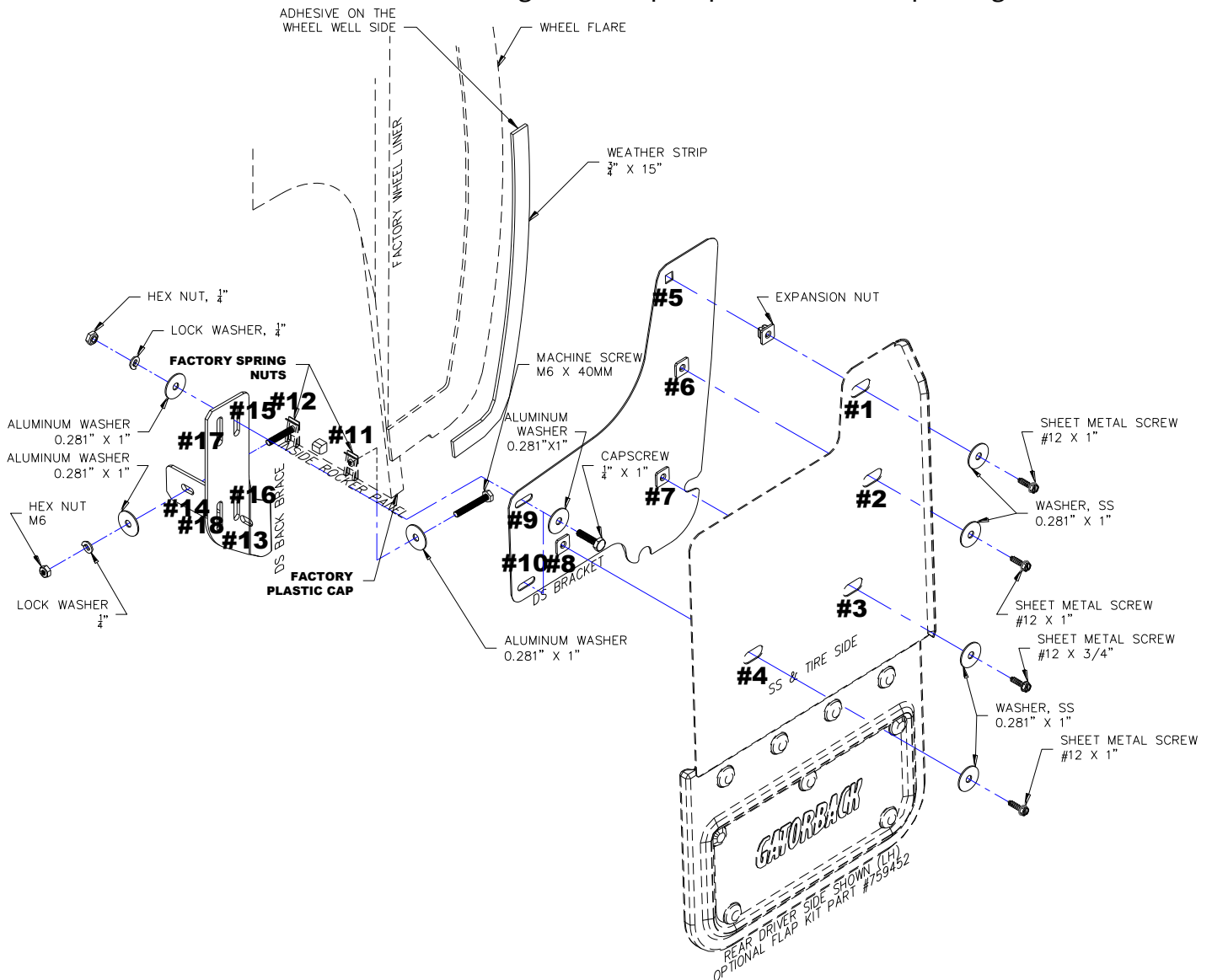

INSTALLATION OF BRACKET WITHOUT FLARE ON STAINLESS STEEL OFFSET FLAPS ONLY:

1. Before you install your Mud Flap Bracket set, see the diagram and parts list for all necessary parts. Start on the driver's side.
2. Temporarily remove the factory plastic cap to get access to the two factory screws on the spring nuts #13 & #14 then remove the two factory screws and replace them with four aluminum washers, two machine screws, two lock washers and two hex nuts through the back brace hole #15 & #16. Ensure the slotted holes of the back brace are mounted center of the machine screws.
3. Snap the expansion nuts into each square holes #5 to #8 of the bracket.
4. Remove two factory screws #11 & #12 and reinstall back to the factory holes #11 & #12 after the bracket is tucked in between the wheel well flange and the wheel liner and the other end of the bracket holes #9 & #10 are bolted to the back brace holes #19 & #20 with four aluminum washers, two capscrews, two lock washers, and two hex nuts (See Diagram)/ Ensure the two factory spring nuts are still in the factory holes #11 & #12.

✓ Check all fasteners for tightness. Repeat procedure on the passenger side.

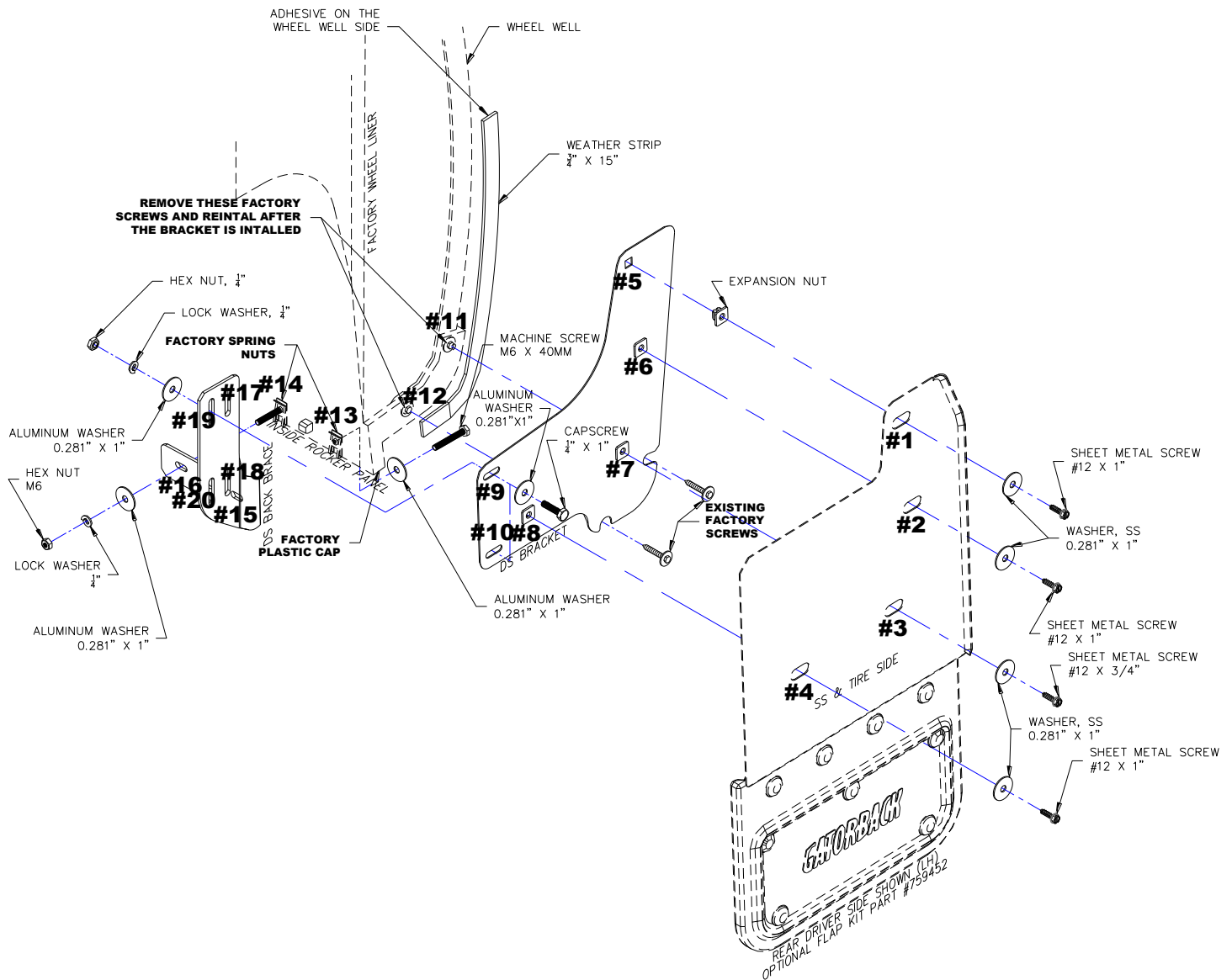

**** NOTICE ****

These instructions and enclosed parts have been provided in response to the Ford 2015 F150 SVE Bulletin. Any deviation of the installation and/or hardware may result in premature corrosion. The manufacturer and/or Dealer Distributor are not responsible for negligent use or installation.