

**IMPORTANT:**

**Manufacturer is not responsible for negligent use of vehicle with mud flaps installed, including over-tightening of screws and bolts causing damage to vehicle or mud flaps.**

## NO-DRILL SYSTEM

### TOOLS REQUIRED

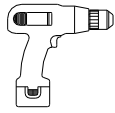

Electric or Chargeable  
 1/2" or 3/8" Drill



3/8" Socket Driver



1/4" Drill Bit

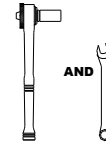

5/16 & 3/8" Open End  
 Wrench & Socket Wrench

### FLAPS

(1) Flap Assembly,  
 Front, DS

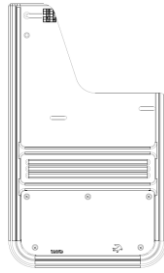

(1) Flap Assembly,  
 Front, PS

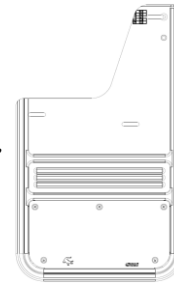

### PARTS BAG # 766127

a) (6) Washer, Flat  
 0.203" x 1", SS  
 Part #018031

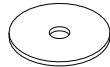

b) (2) Washer, Lock  
 #10, Helicoil, SS  
 Part #024001



c) (2) Hex Nut  
 #10, SS  
 Part #025003



d) (2) Screw, Machine  
 #10 x 1.5"  
 Part #012027

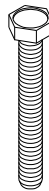

e) (2) Washer, Half, SS  
 0.203" x 1"  
 Part #018032

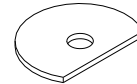

### INSTALLATION

1. Before you install your Gatorback Mud Flap, see the diagram and parts list for all necessary parts.
2. Remove two (2) factory screws #4 & #5. Using the two (2) factory screws and included washers #018031, reinstall on holes #1 & #2. Loosely secure at this point.
3. Square the flap with the tire, while putting pressure against the wheel well, then tighten the two (2) factory screws #4 & #5.
4. Hold flap tight against wheel well and drill a 1/4" hole (1), from the center of the slotted hole #3 through the factory plastic liner. Secure the flap with one (1) machine screw #012027, one (1) flat washer #018031, one (1) half washer #018032, one (1) lock washer #024001 and one (1) hex nut #025003.
5. Repeat procedure for passenger side.

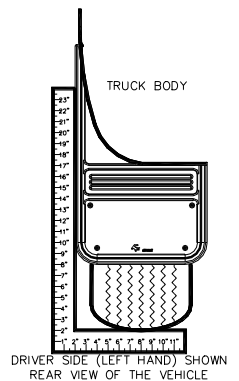

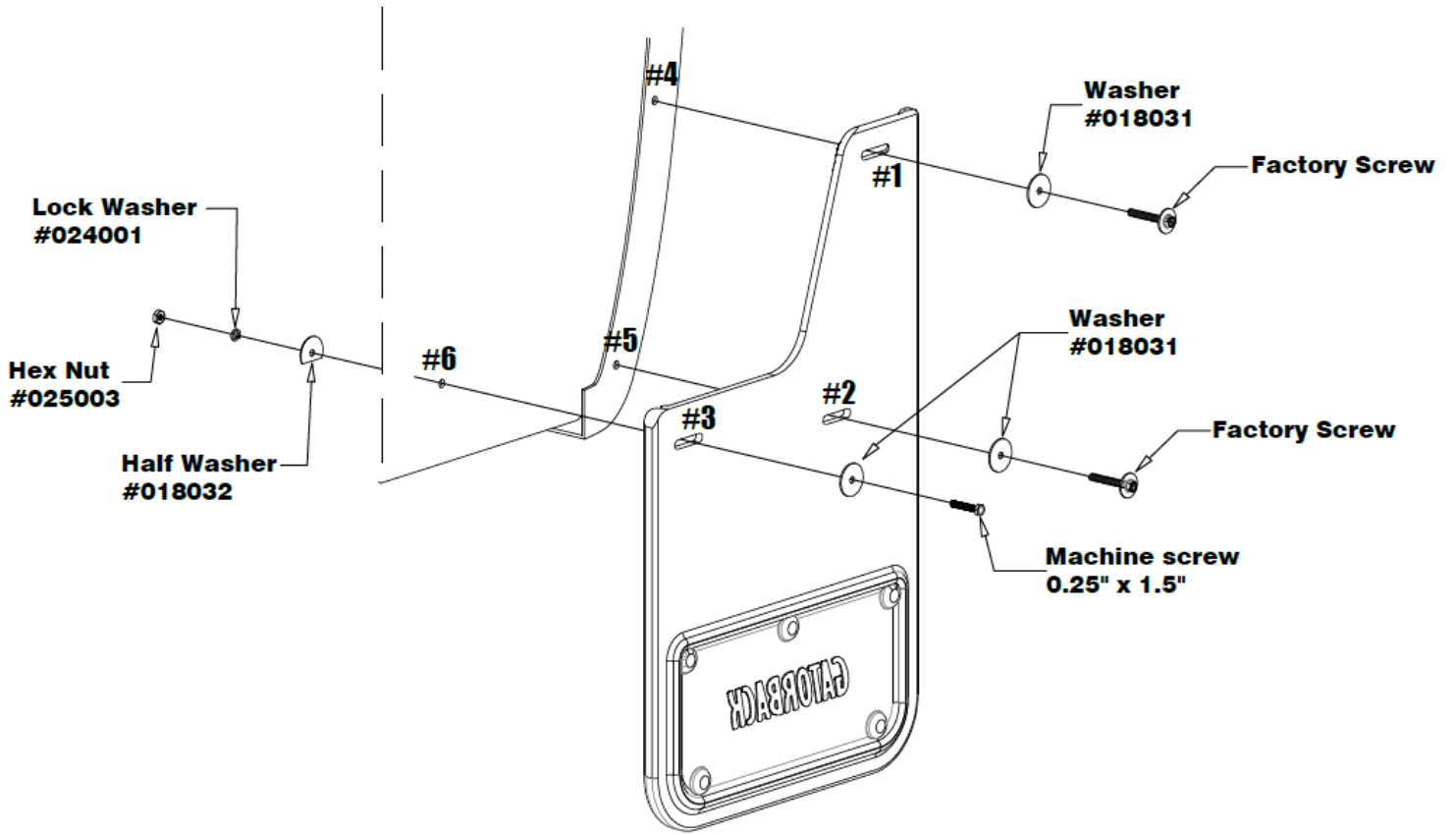

Please check out our YouTube channel to see an install video for this application.

