

# Kit 1420

**CHEVROLET Aveo**, 4-dr Sedan, 06- / \*04-06, 07-

**CHEVROLET Lova**, 4-dr Sedan, 06-

**DAEWOO Gentra**, 4-dr Sedan, 06-

**DAEWOO Kalos**, 4-dr Sedan, 06-

**HOLDEN Barina**, 4-dr Sedan, 06-

**PONTIAC G3**, 4-dr Sedan, 06- / \*07-09

**PONTIAC Wave**, 4-dr Sedan, 06- / \*04-06, 07-

\*North America

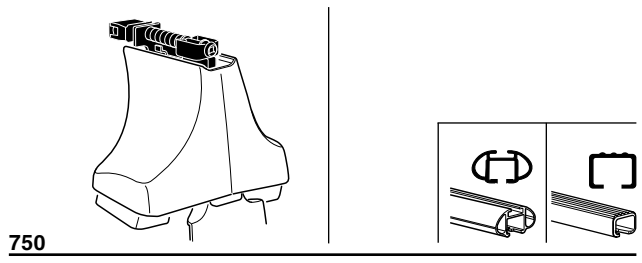
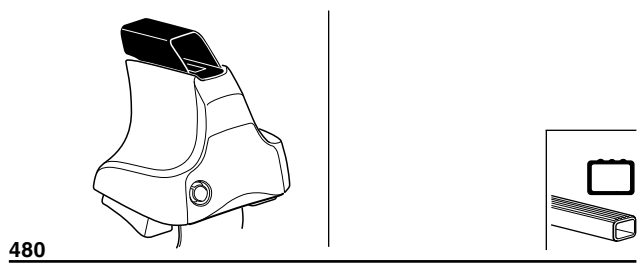
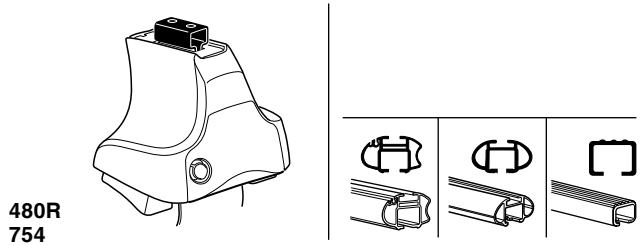

x2 x2 x2 x4	x2	x2 x2 x4 x4	x2 x2	x2

**368** x 2  
**784** x 2

**179** x 1  
**181** x 1  
**258** x 2

x 1

**Kit**

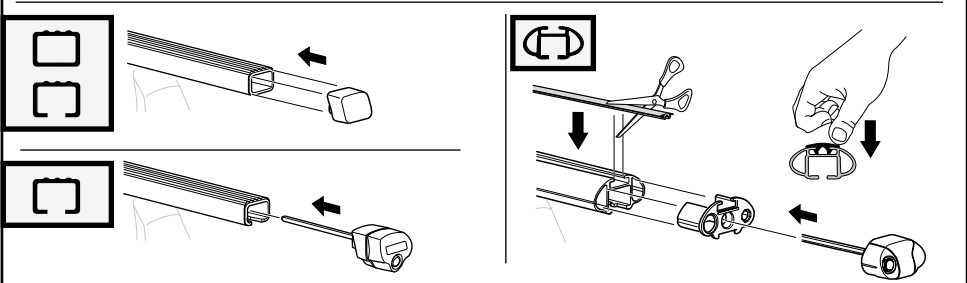
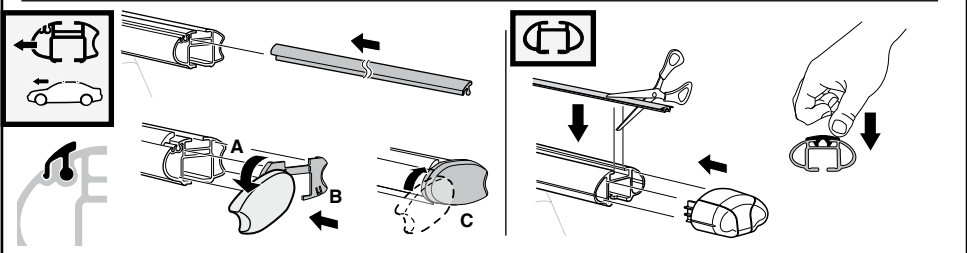
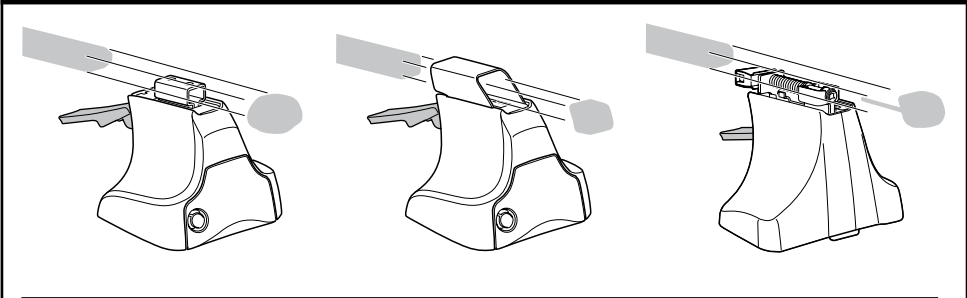
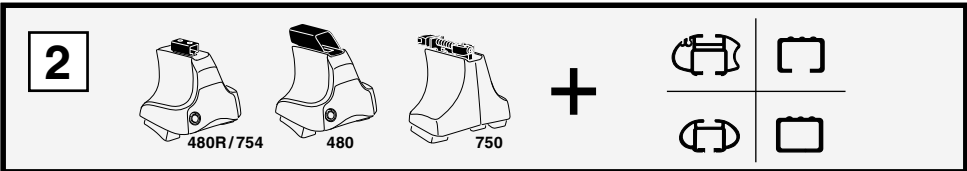
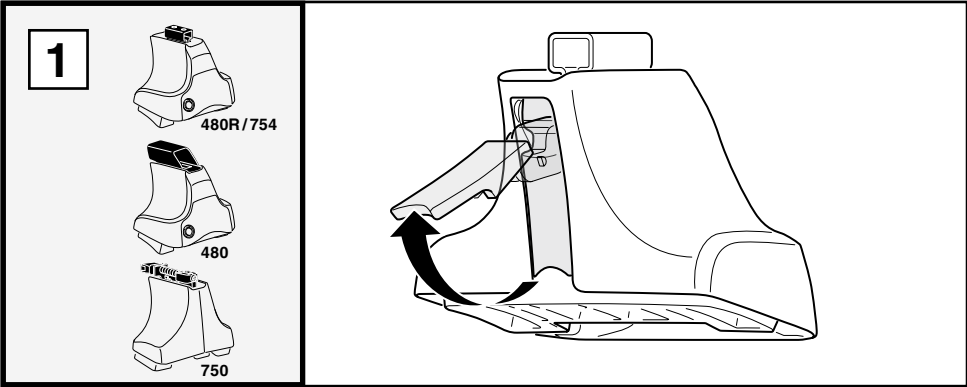

3

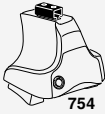

754

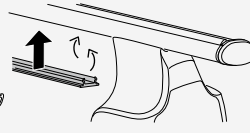
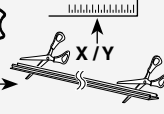

750

1

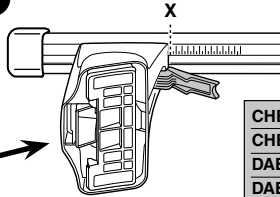
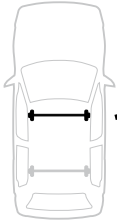

2

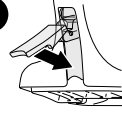

X

CHEVROLET Aveo, 4-dr Sedan, 06- / *04-06, 07-	28
CHEVROLET Lova, 4-dr Sedan, 06-	28
DAEWOO Gentra, 4-dr Sedan, 06-	28
DAEWOO Kalos, 4-dr Sedan, 06-	28
HOLDEN Barina, 4-dr Sedan, 06-	28
PONTIAC G3, 4-dr Sedan, 06- / *07-09	28
PONTIAC Wave, 4-dr Sedan, 06- / *04-06, 07-	28

1

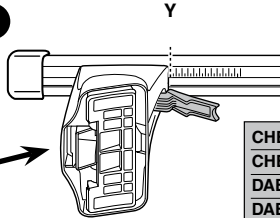

2

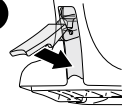

Y

CHEVROLET Aveo, 4-dr Sedan, 06- / *04-06, 07-	22
CHEVROLET Lova, 4-dr Sedan, 06-	22
DAEWOO Gentra, 4-dr Sedan, 06-	22
DAEWOO Kalos, 4-dr Sedan, 06-	22
HOLDEN Barina, 4-dr Sedan, 06-	22
PONTIAC G3, 4-dr Sedan, 06- / *07-09	22
PONTIAC Wave, 4-dr Sedan, 06- / *04-06, 07-	22



480R



480

1

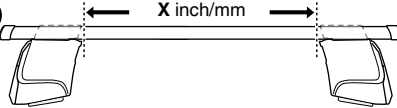

2

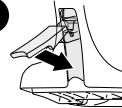

X inch | X mm

CHEVROLET Aveo, 4-dr Sedan, 06- / *04-06, 07-	36 <sup>5</sup> / <sub>8</sub> "	931 mm
CHEVROLET Lova, 4-dr Sedan, 06-	36 <sup>5</sup> / <sub>8</sub> "	931 mm
DAEWOO Gentra, 4-dr Sedan, 06-	36 <sup>5</sup> / <sub>8</sub> "	931 mm
DAEWOO Kalos, 4-dr Sedan, 06-	36 <sup>5</sup> / <sub>8</sub> "	931 mm
HOLDEN Barina, 4-dr Sedan, 06-	36 <sup>5</sup> / <sub>8</sub> "	931 mm
PONTIAC G3, 4-dr Sedan, 06- / *07-09	36 <sup>5</sup> / <sub>8</sub> "	931 mm
PONTIAC Wave, 4-dr Sedan, 06- / *04-06, 07-	36 <sup>5</sup> / <sub>8</sub> "	931 mm

1

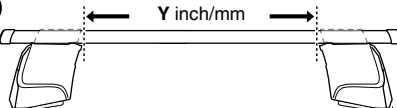

2

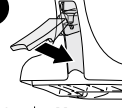

Y inch | Y mm

CHEVROLET Aveo, 4-dr Sedan, 06- / *04-06, 07-	34 <sup>1</sup> / <sub>4</sub> "	871 mm
CHEVROLET Lova, 4-dr Sedan, 06-	34 <sup>1</sup> / <sub>4</sub> "	871 mm
DAEWOO Gentra, 4-dr Sedan, 06-	34 <sup>1</sup> / <sub>4</sub> "	871 mm
DAEWOO Kalos, 4-dr Sedan, 06-	34 <sup>1</sup> / <sub>4</sub> "	871 mm
HOLDEN Barina, 4-dr Sedan, 06-	34 <sup>1</sup> / <sub>4</sub> "	871 mm
PONTIAC G3, 4-dr Sedan, 06- / *07-09	34 <sup>1</sup> / <sub>4</sub> "	871 mm
PONTIAC Wave, 4-dr Sedan, 06- / *04-06, 07-	34 <sup>1</sup> / <sub>4</sub> "	871 mm

**4**

CHEVROLET Aveo, 4-dr Sedan, 06- / \*04-06, 07-  
CHEVROLET Lova, 4-dr Sedan, 06-  
DAEWOO Gentra, 4-dr Sedan, 06-  
DAEWOO Kalos, 4-dr Sedan, 06-  
HOLDEN Barina, 4-dr Sedan, 06-  
PONTIAC G3, 4-dr Sedan, 06- / \*07-09  
PONTIAC Wave, 4-dr Sedan, 06- / \*04-06, 07-

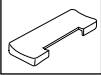
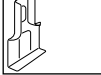
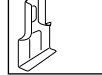
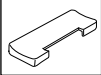
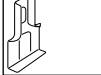
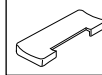
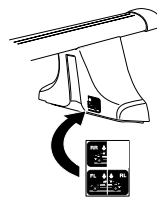
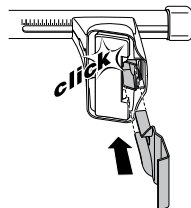
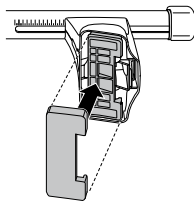
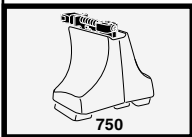
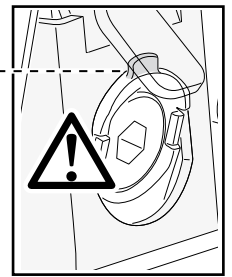
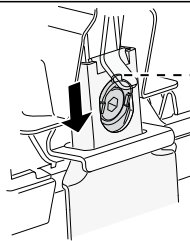
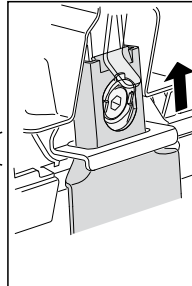
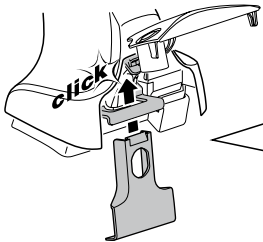
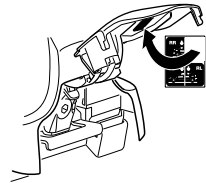
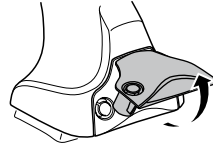
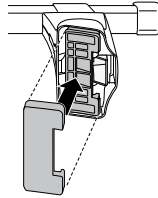
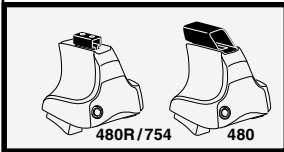
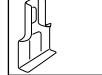
**179****784****181****784****258****368****258****368**

5

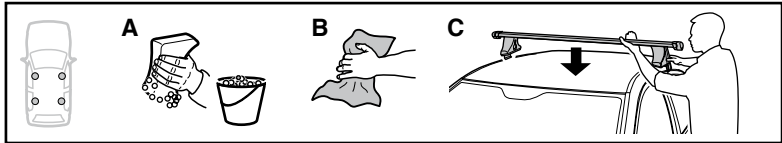

	X mm	Y mm	X inch	Y inch
<b>CHEVROLET Aveo</b> , 4-dr Sedan, 06- / *04-06, 07-	250 mm	700 mm	9 <sup>7</sup> / <sub>8</sub> "	27 <sup>1</sup> / <sub>2</sub> "
<b>CHEVROLET Lova</b> , 4-dr Sedan, 06-	250 mm	700 mm	9 <sup>7</sup> / <sub>8</sub> "	27 <sup>1</sup> / <sub>2</sub> "
<b>DAEWOO Genra</b> , 4-dr Sedan, 06-	250 mm	700 mm	9 <sup>7</sup> / <sub>8</sub> "	27 <sup>1</sup> / <sub>2</sub> "
<b>DAEWOO Kalos</b> , 4-dr Sedan, 06-	250 mm	700 mm	9 <sup>7</sup> / <sub>8</sub> "	27 <sup>1</sup> / <sub>2</sub> "
<b>HOLDEN Barina</b> , 4-dr Sedan, 06-	250 mm	700 mm	9 <sup>7</sup> / <sub>8</sub> "	27 <sup>1</sup> / <sub>2</sub> "
<b>PONTIAC G3</b> , 4-dr Sedan, 06- / *07-09	250 mm	700 mm	9 <sup>7</sup> / <sub>8</sub> "	27 <sup>1</sup> / <sub>2</sub> "
<b>PONTIAC Wave</b> , 4-dr Sedan, 06- / *04-06, 07-	250 mm	700 mm	9 <sup>7</sup> / <sub>8</sub> "	27 <sup>1</sup> / <sub>2</sub> "

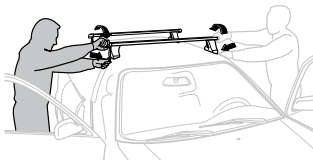
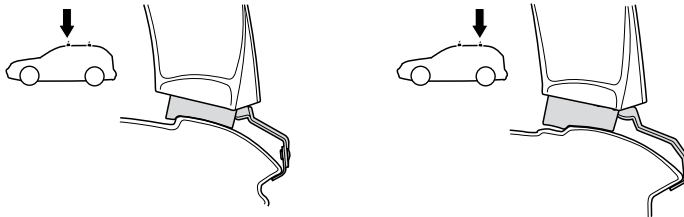
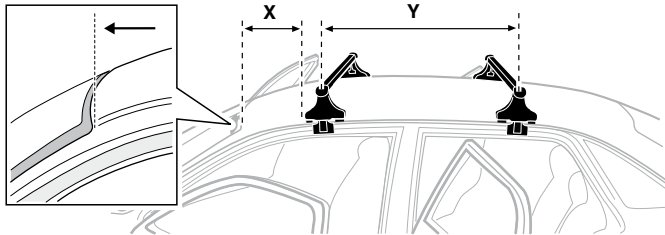

**GB/US** Tighten alternately  
**D** Die Schrauben abwechselnd anziehen  
**F** Serrer alternativement chaque côté  
**NL** Afwisselend aan de linker- en de rechterkant aandraaien  
**I** Alternare il serraggio delle viti  
**E** Serrare alternativamente  
**PT** Aperte alternadamente  
**S** Dra åt växelvis  
**FIN** Kierrä vuorotellen  
**EST** Pinguldage vaheldumisi  
**LAT** Pielvecliet pamīšus  
**LIT** Užsukinėkite pakaitomis  
**PL** Śruby dokręcaj naprzemiennie  
**RU** Затягивайте попеременно

**CZ** Pokrętła bagażnika dokręcaj dokręcaj naprzemiennie.  
**SK** Dofahujte striedavo  
**SLO** Privijajte izmenično.  
**HR** Naizmjenično zategnite  
**HU** Egymástól függetlenül szorítandó  
**GR** Σφίγγετε εναλλάξ  
**TR** Dönüşümlü sıkın  
**中文** 交替拧紧  
**한국어** 번갈아 가며 조이십시오.  
**日本語** 交互に締め付けてください。  
**ไทย** ชั่วในแบบสลับ

6

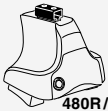

480R/754



480

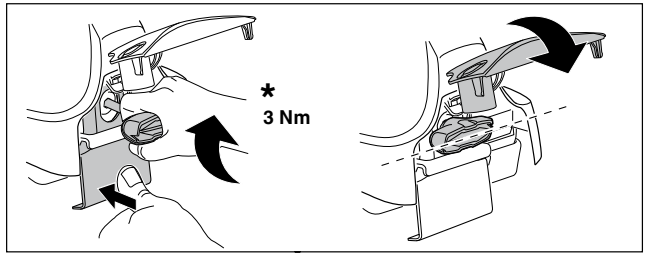
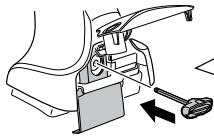

\*  
3 Nm

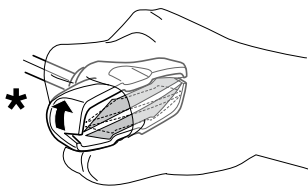

\*

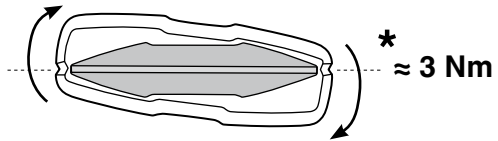

\*  
≈ 3 Nm

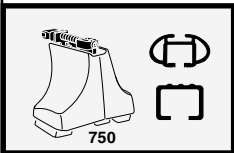
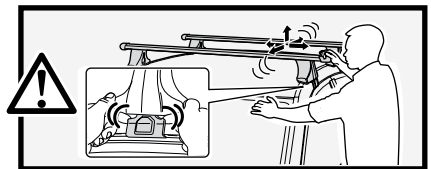

750

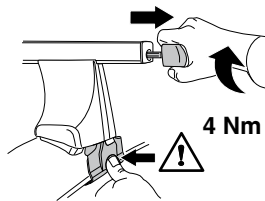

4 Nm

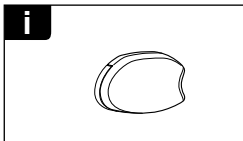
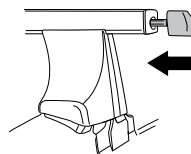

i

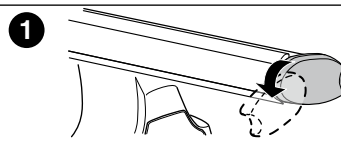

1

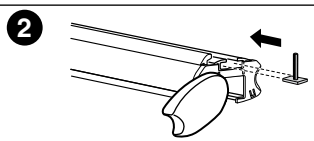

2

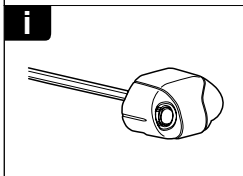

i

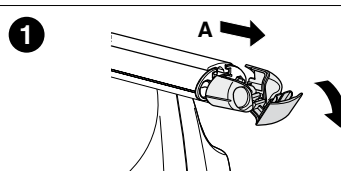

1

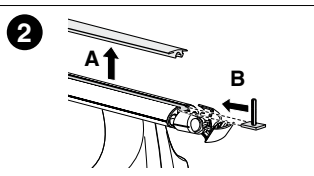

2

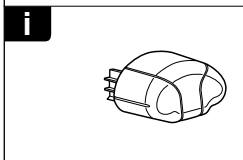

i

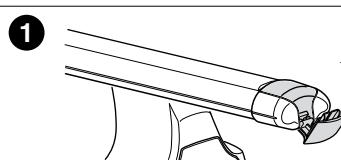

1

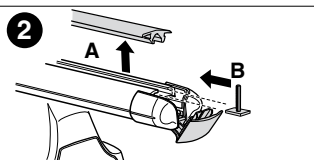

2

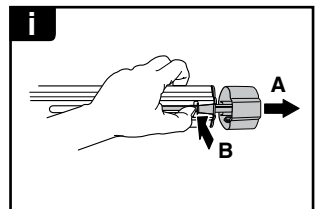
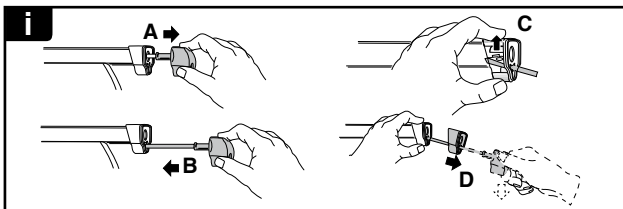
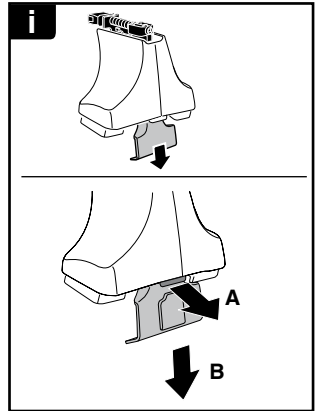
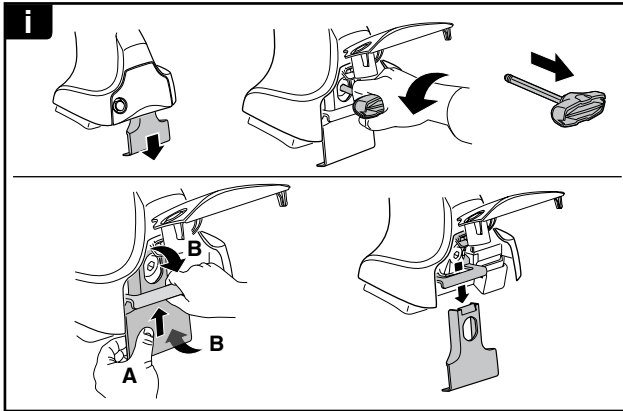
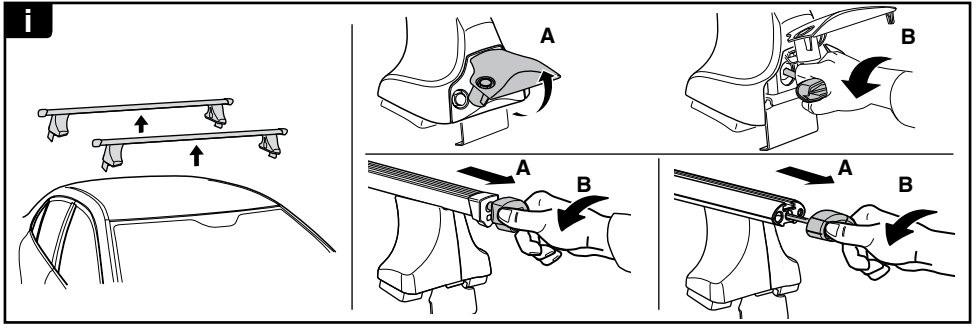

**THULE**  
SWEDEN  
**ONE  
KEY  
SYSTEM**

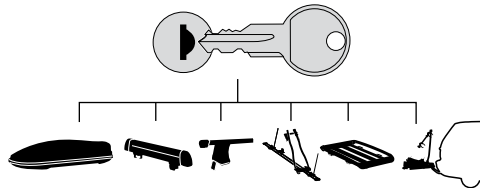

- 544** (x4)
- 596** (x6)
- 588** (x8)
- NA **510** (x10)
- EUR **452** (x12)
- ASIA

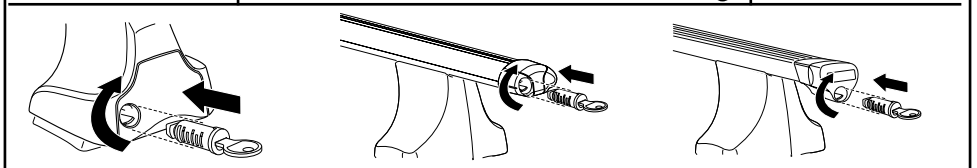

WW ▶ Thule Sweden AB, Box 69, 330 33 Hillerstorp, SWEDEN  
NA ▶ Thule Inc., 42 Silvermine Road, Seymour, Connecticut 06483, USA

info@thule.com  
customer.service@thule.com

www.thule.com